



Design — For — Distancing —>

Ideas Guidebook

Designs, public health resources and more to support quick, safe public space activations.



Design
For
Distancing

REOPENING BALTIMORE TOGETHER

AN INITIATIVE BY



the
**Neighborhood
DesignCenter**



JUNE 29, 2020
DESIGNFORDISTANCING.ORG

CONTENTS

- 3** Intro
- 7** Team + Stakeholders
- 9** Design Brief Summary
- 11** How to Use This Guide
- 14** Concept Plans
- 55** Public Health Guidelines
- 60** Additional Resources

About this project

The Design for Distancing Ideas Guidebook is part of **Design for Distancing: Reopening Baltimore Together**, a program of the City of Baltimore, Office of the Mayor and the Baltimore Development Corporation, in partnership with local nonprofit the Neighborhood Design Center.

Developed in the summer of 2020 in response to COVID-19 and the challenges faced by local businesses, the Design for Distancing program called on Baltimore's world class design and public health communities to develop innovative approaches to safe, physically distant gathering.

The first outcome of this work is the **Ideas Guidebook**, a compendium of ten concepts for public space interventions that can be adapted for and installed in cities all over the world. Designs for the Guidebook were solicited through a global call for entries. From hand-drawn sketches by children to professional renderings, 162 concepts were submitted from Baltimore and around the country.

A review panel composed of experts from the Johns Hopkins Bloomberg School of Public Health, leaders from the City of Baltimore and from the Baltimore small business and design communities voted on designs, ultimately selecting ten. Design teams partnered with the Neighborhood Design Center to finalize their concepts for the Guidebook, and each eligible team was awarded a \$5,000 stipend. The Ideas Guidebook is available for free download by anyone.



Designs in the Guidebook will also serve as a jumping off point for the second part of Design for Distancing—**Public Space Interventions**. Through a \$1.5M investment from Baltimore City’s COVID-19 Small Business Assistance Initiative, temporary public space interventions will be installed in 17 Baltimore City Districts. Each District has been paired with a local design-build team to scope, develop, and implement public space interventions. Design-build teams will be offered a design stipend, and the construction will be funded through the Baltimore Development Corporation.

In July 2020, versions of these temporary Public Space Interventions will be customized and implemented across Baltimore City, including current and former Main Streets, Retail Business Licensing Districts (RBLD), and Arts & Entertainment Districts identified as priority areas for the Small Business Assistance Fund grant program. Participating Districts are: Belair-Edison, Brooklyn, East Monument Street, Federal Hill, Govanstowne, Hamilton-Lauraville, Hampden, Highlandtown, Hollins Market, Market Center, Midtown/Station North, Mount Washington, Oldtown Mall, Pennsylvania Avenue, Pigtown, Pimlico, and Waverly.

We’re thrilled to share the brilliant ideas of our ten designers. Even more, we can’t wait to see safe, creative Public Space Interventions realized and activated in our cities’ public spaces—for everyone.

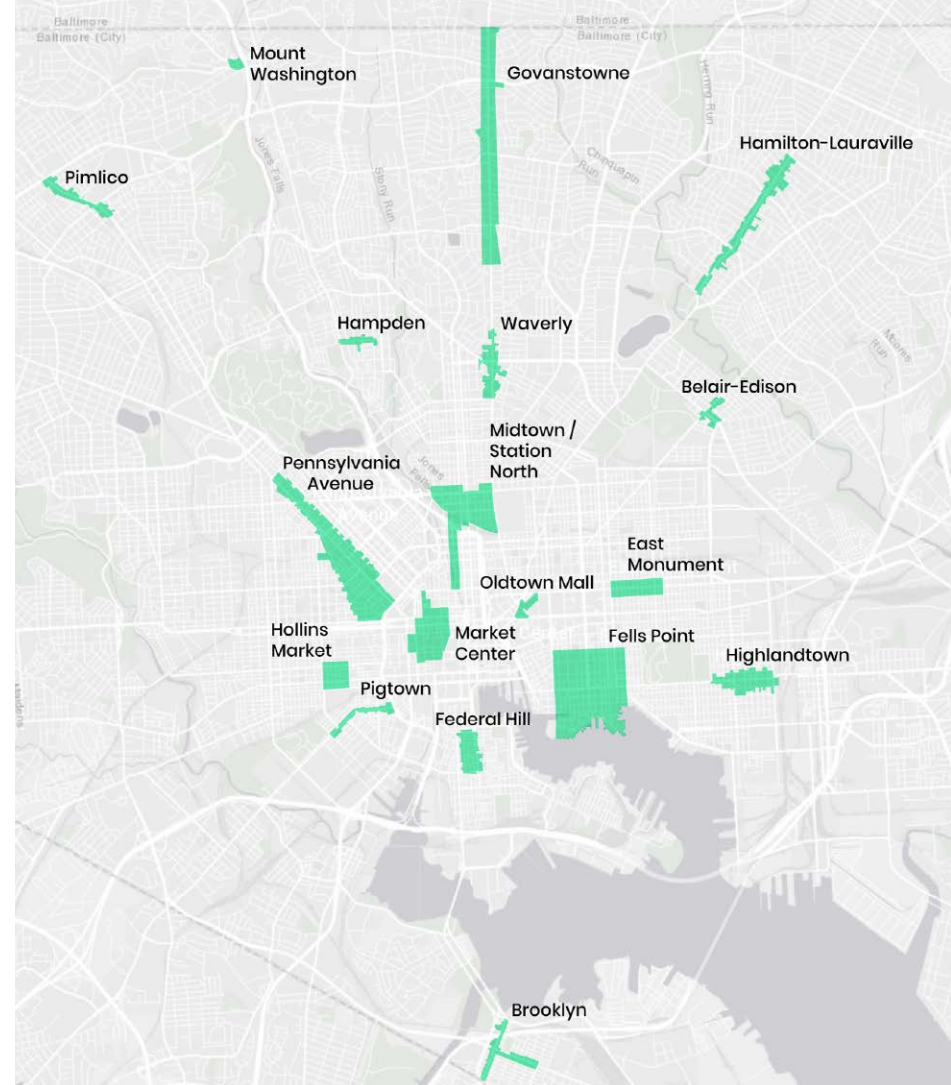

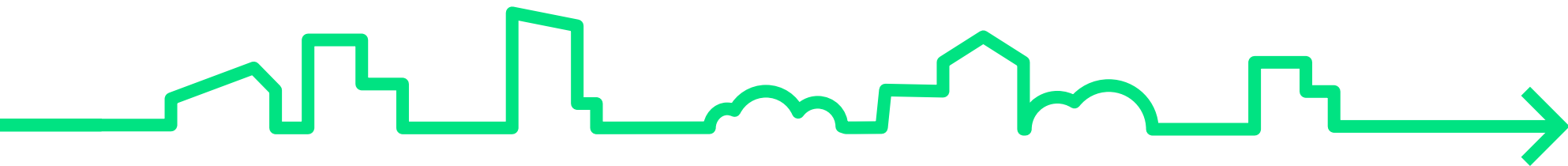

“

To say that this has been a very challenging time for the world would be an understatement.

Beyond the immeasurable magnitude of human loss, we know the economic impact of COVID-19 has severely affected small businesses and their employees. We have seen our long-standing businesses struggle through this public health emergency, and many residents face unemployment.

In an effort to help our small business community, the City of Baltimore created the COVID-19 Small Business Initiative, which established a **\$5.5 million fund** to provide financial assistance to small businesses, as well as other resources and guidelines to help businesses reopen without compromising public health.

Here in Baltimore and around the world, streets, sidewalks and stoops are important gathering spaces, and in many ways the intersection of our lives. Recapturing these areas is critical to our reopening and economic recovery but public health must remain at the forefront of every move we make.

To that end, we allocated **\$1.5 million for the Design for Distancing initiative** in order to reconfigure public right of way and public spaces to maximize outdoor seating and other business needs to provide ways to create more social distancing in Main Streets, and Retail Business License Districts and certain commercial districts.

Working in partnership with the Johns Hopkins Bloomberg School of Public Health, the Baltimore Development Corporation, the Neighborhood Design Center, and local stakeholders, we invited the public to submit innovative solutions that safely allow our economies and public lives to open up again. Out of **162 submissions**, a jury selected the top ten tactical designs. In addition to implementing versions of them throughout Baltimore City, we felt it was important to share these creative concepts with other cities to adapt and use as needed.

This Guidebook is Baltimore’s gift to the world, and we hope it will be a valuable resource to areas far beyond our city.”

Bernard “Jack” C. Young
Mayor, City of Baltimore

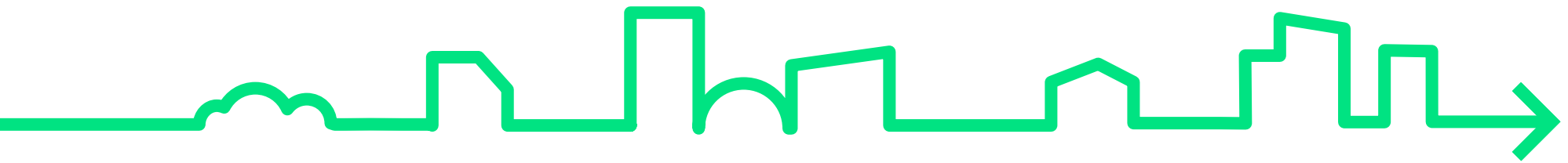

“

While the spread of COVID-19 brought our community together in many ways, it disrupted the way of life for so many—especially small businesses.

Some have been busier than ever. Some are hanging on. Some may never recover.

Now, as restrictions lift and we begin to allow our lives and economies to resume in the new normal, reopening using public health best practices will require businesses to make new and significant adjustments to their operation and capacity. The spaces inside and out will also require creative interventions from now until the winter and possibly beyond.

Because Baltimore is home to some of the most capable and brightest public health experts, designers, makers and innovators, we had the chance to be a leader in creating new urban models for physical distancing. We are extremely proud of the Design for Distancing initiative, not only for what it means for the economic recovery, public health and safety in neighborhoods throughout Baltimore, but for how it can help the rest of the world do the same.

When we step outside of our homes, safely patronizing neighborhood stores, services, and restaurants will be crucial to our total recovery. When our small businesses thrive, our residents and neighborhoods do also.”

**Colin Tarbert, President & CEO,
Baltimore Development Corporation**

About Baltimore Development Corporation

The Baltimore Development Corporation (BDC) is the economic development agency for the City of Baltimore. Its mission is to grow the city's economy in an inclusive manner by retaining, expanding and attracting businesses and promoting investment, thereby increasing career opportunities for residents.

About Neighborhood Design Center

Since 1968, Neighborhood Design Center (NDC) has helped low and moderate income communities build new playgrounds, reclaim abandoned buildings and vacant lots, develop affordable housing, revitalize commercial districts and create neighborhood master plans.

With offices in the Station North area of Baltimore and in Hyattsville, Maryland, NDC's assistance strengthens civic participation in development initiatives, educates the public about the value of good design, planning and preservation as community revitalization tools, and increases investment in the responsive rebuilding of neighborhoods.

Learn more at ndc-md.org



Project Management

BALTIMORE DEVELOPMENT CORPORATION

Kimberly Clark
Christina Moore
Colin Tarbert
Patrick Terranova

NEIGHBORHOOD DESIGN CENTER

Karla Brent
Katryna Carter
Jennifer Goold
Merrell Hambleton
Sophie Morley
Dana Puzey

MEDIA TEAM

Nicole Atkinson, Media Relations
Tammira Lucas, Social Media
Kacie Mills, Graphic Design

Stakeholder Committee

This project would not have been possible without the generous and thoughtful contributions of our Stakeholder Committee members. We thank them for their time and effort.

Adam Abadir, Baltimore City Health Department

Matt Achhammer, Board of Liquor License Commissioners

Cole, Dovecote Cafe

Wanda Best, Upton Planning Committee

Emily Breiter, Bromo Arts District

Francis Burnszynski, Baltimore City Parking Authority

Liz Cornish, Bikemore

Aisha Dickerson, Johns Hopkins Bloomberg School of Public Health

Aisha Pew, Dovecote Cafe

Anne Draddy, Baltimore Office of Sustainability

Jules Dunham Howie, UPC Westside CDC

Cathy Rosenbaum, Federal Hill Main Street

Laurie Feinberg, Baltimore Department of Planning

David Framm, Baltimore Department of Transportation

Mary Beth Haller, Baltimore City Health Department

Shima Hamidi, Johns Hopkins Bloomberg School of Public Health

Chad Hayes, Baltimore Department of Planning

Kelley Heuisler, Poppy & Stella

Tim Knight, Baltimore Department of Transportation

Megan Latshaw, Johns Hopkins Bloomberg School of Public Health

Anna Leventis, SoBo Café

Sylva Lin, Culinary Architecture

John Malinowski, Baltimore City Department of Transportation

Yeeli Mui, Johns Hopkins Bloomberg School of Public Health

Keshia Pollack Porter, Johns Hopkins Bloomberg School

of Public Health

Steven Preston, Parks & People

Shayna Rose, Baltimore City Department of Transportation

Laurie Schwartz, Waterfront Partnership

Joshua Sharfstein, Johns Hopkins Bloomberg School of Public Health

Nanette Smith, Bloomberg Philanthropies

Renata Southard, Baltimore Department of Planning

Craig Stoner, EDSA*

Lucy Wilson, University of Maryland, Baltimore County

Graham Young, Baltimore City Department of Transportation

Mikah Zaslow, Baltimore City Department of Transportation

**Did not participate in evaluation of submitted Concept Sketches.*

Design Brief

With the support of the Stakeholder Committee, Baltimore Development Corporation and the Neighborhood Design Center developed a brief for design concepts that prioritized physical distancing, public health, and inclusiveness.

[You can read the full brief here.](#)

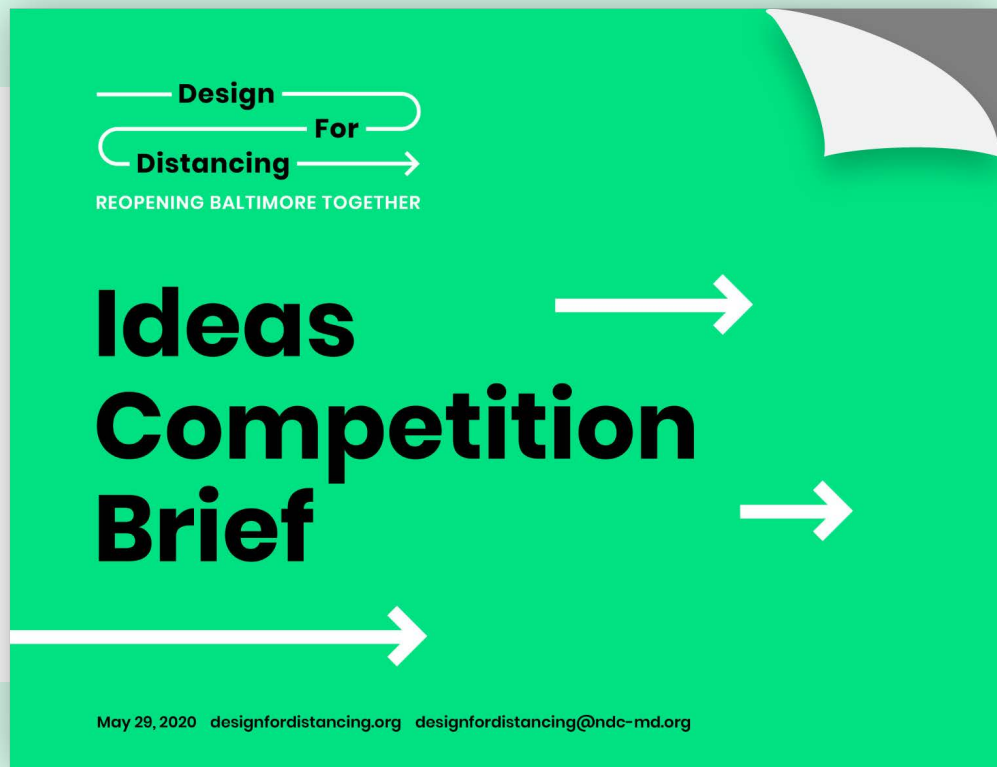



Framing + Vision

PRIORITY WAS GIVEN TO CONCEPTS THAT

- Are inclusive, healthy and equitable
- Focus on the concept of “physical distancing” vs. “social distancing”—we still want people to gather, but to gather safely
- Support a return to thriving business
- Create spaces that people actually use
- Employ clear, helpful messaging (in appropriate languages for the host community)
- Embrace the best practices, energy and warmth of pedestrian-oriented cities
- Reflect and amplify the existing character of the surrounding neighborhood
- Are executable in a very short time frame
- Are unique, warm, engaging, and safe
- Surprise, delight and reimagine

**Some of the key issues
Design Teams were
asked to consider.**

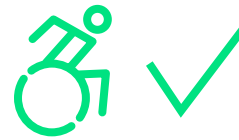

Key Considerations

ALL SUBMITTED DESIGNS WERE REQUIRED TO

- Be temporary (while considering the possibility of permanent installation)
- Be low-cost (installation budget of \$30K to \$100K)
- Address the needs of food service, retail, and other service industries
- Be situated outdoors in public space (i.e. the sidewalk, closed streets, parking spaces, vacant lots, parking lots)
- Be people-focused (those using the streets, parks, public spaces and especially those patronizing local businesses)
- Both incorporate public health guidelines and communicate how to use spaces in order to maintain those guidelines
- Support the safety of users, and communicate that safety is being considered
- Consider a range of users and groups and support their safe interaction (from young children to seniors; from single person to large family, differently abled patrons, etc.)
- Prioritize durable, reusable, and sustainable materials and construction methods that allow pieces to be disassembled and reconstructed elsewhere
- Prioritize visibility, legibility, and easy compliance to the greatest extent possible

How to Use this Guidebook

The designs presented in this book are intended to **serve as templates** for public space interventions in urban commercial districts.

Many of the designs use Baltimore as a site, but each intervention can be adapted to different spaces and scales—from a small parklet to a closed block or streetscape.

When choosing design concepts, we attempted to show a **range of intervention typologies**. You'll see designs that are specific to entertainment, retail, outdoor dining, and queuing. There is also a diversity of sites, from individual vacant lots and parking spaces to parks, parking lots, and entire main streets.

The goal is to make it simple for other towns and cities to determine which interventions are the best match for their budget and capacity. Note that many of the designs are **modular**. This means that while some are presented at a full lot or block scale—and at a high level of investment—it's possible to adapt for a smaller space and budget.

We've also included a list of key materials for each project to help you identify interventions for which you may already have necessary parts.

We worked with Design Teams to determine the **relative cost, level of maintenance, and level of fabrication** required for each concept.

You'll see these levels represented by graphic scales, with one dollar sign, paint brush, or hammer indicating the lowest investment and five indicating the highest investment.

All concepts are budgeted between **\$5K and \$100K**.



Any design from the Ideas Guidebook must be customized to fit its site.

Best practices and adaption suggestions

- Before selecting a design template or specific site, establish a **working group** that includes local stakeholders and community members to identify the need and frame the scope of the intervention.
- Understand your municipality's constraints around **permitting** for temporary interventions to help establish scope. If possible, establish direct communication with members of the permitting departments at the outset.
- Establish your capacity, from budget for the project to day to day maintenance.
- Collaboratively determine the best site for an intervention. Each of the designs contained in this book are intended for **public sites** that serve a range of businesses. Site selection should account for site control, which varies widely. Determine who controls the site, then **get their blessing** before moving forward with plans.
- Customize designs to the aesthetic and culture of your place, from colors and icons to language.
- Whenever possible, make space for **community feedback** on proposed designs. This might take the form of a public forum, listening session, online survey or town hall.
- In addition to the **public health** recommendations in this book, reference your municipality's guidelines on safe physical distancing.
- **Signage** is critical to helping users understand how to safely navigate interventions. Make sure to include clear signage that instructs users on how to maintain safe distance and reminds them to wash their hands, use hand sanitizer, and wear a mask. All signage should be offered in **languages** that represent the host community.

DESIGN TEAMS

Selected Designs

Out of 162 Concept Sketch submissions, ten design teams were chosen to advance their ideas for inclusion in this Guidebook. We congratulate them on their brilliant interventions, and thank them for their hard work.

View all of the submitted Concept Sketches on Instagram

[@designfordistancing](https://www.instagram.com/designfordistancing)

or on the Design for Distancing website

designfordistancing.com

Curblet Commons

Graham Projects
Graham Coreil-Allen

Organizing the Street

EDSA
Craig Stoner, Terri Wu

Hygiene, Hon

Ziger|Snead Architects
Doug Bothner, Jeremy Chinnis,
Cyrus Lee, Kelly Danz

The Food Court

Department Design Office
Maggie Tsang, Isaac Stein

Make ApART

Quinn Evans
Ethan Marchant, Steve Schwenk

inFRONT of House

PI.KL
Pavlina Ilieva, Kuo Pao Lian,
Brian Baksa, Esther Cho

ParKIT

Ayers Saint Gross
Abby Thomas, Michael McGrain,
Connor Price

MicroDistrict

Yard & Company, &Access
Joe Nickol, Kevin Wright, Bobby
Boone

Find Your Tropical Island

Christopher Odusanya

Space Frame

Zoe Roane-Hopkins

Concept Plans



Curblet Commons

Curblet Commons

GRAHAM PROJECTS
GRAHAM COREIL-ALLEN

“Curblet Commons” converts a parking lane into a public space for community, shopping, services, and culinary encounters.

The “Rampin’ Over” ADA curb ramps provide adjustable height mobility access midblock. The “Wingin’ It” hinged partitions may be set at different angles to appropriately frame spatial distance. Precast planters anchor the separators, provide beautification, and serve as protective barriers for curb-lyfe enthusiasts.

From the “Gridn’ Safe” modular stencils participants take visual and tactile cues for maintaining their publicly healthy personal space. The customizable footprints and 6’ by 6’ grid system are applied using spray paint and epoxy paint enhanced with pea gravel to be foot-felt by those visually impaired.

City-installed traffic bump-outs define the space with line striping, flex-posts, and bike racks. Artful, high-contrast painted designs visually unifying the Curblet Commons while demarking the former site of publicly subsidized car storage as a premiere safe space for pedestrian conviviality and commerce.

COST



MAINTENANCE



FABRICATION



MATERIALS

- **Unfinished, painted or powder coated aluminum sheet**
- **Color Board HDPE or Lusterboard ACM**
- **Piano Hinges**
- **Leveling feet**
- **Steel feet**
- **Gusset plate**
- **Epoxy paint and gravel**
- **Planters**
- **Stencils**

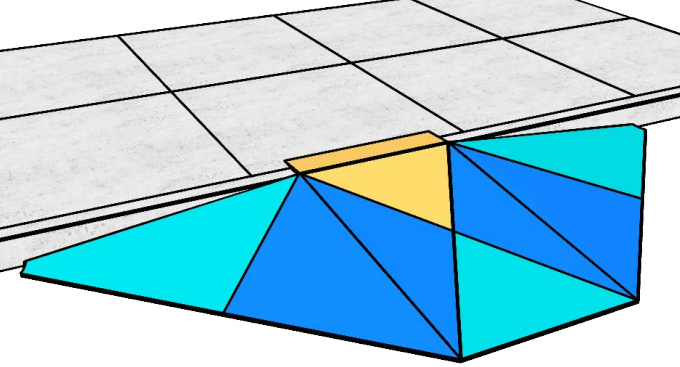

Rampin' Over moveable ADA curb ramp perspective

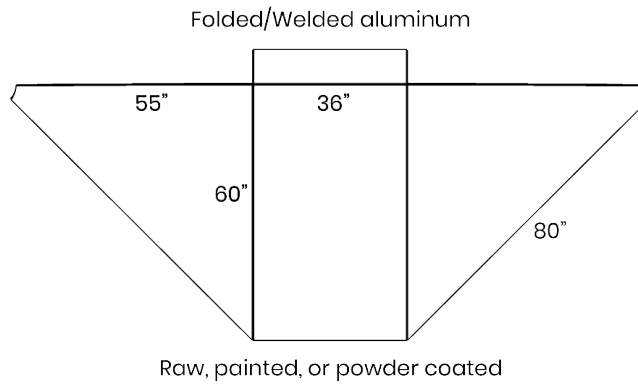

Rampin' Over plan

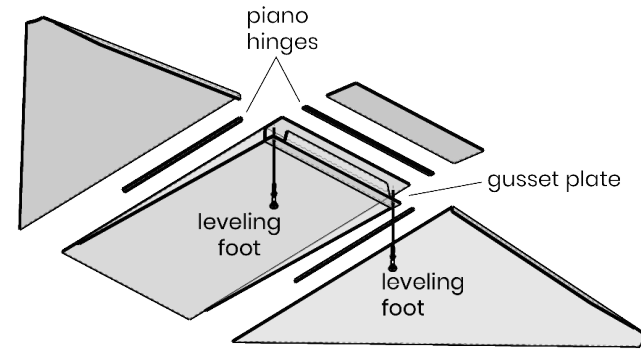

Rampin' Over structure & components details

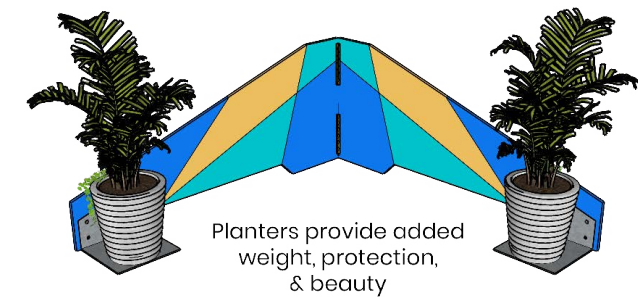

Wingin' It hinged partition inner perspective

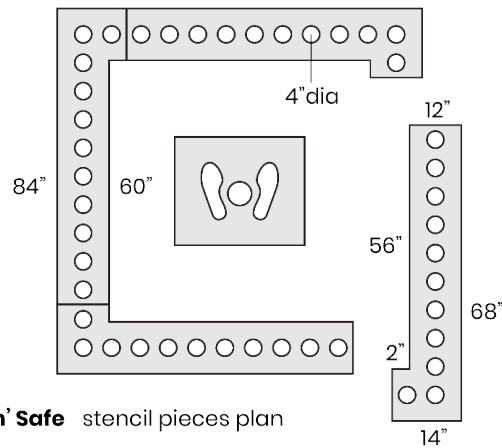

Gridn' Safe stencil pieces plan

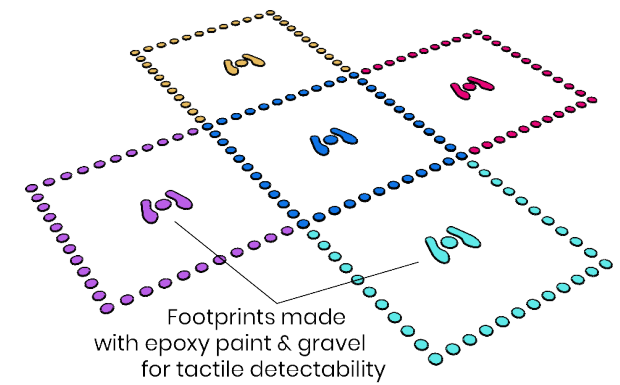

Gridn' Safe stencils perspective

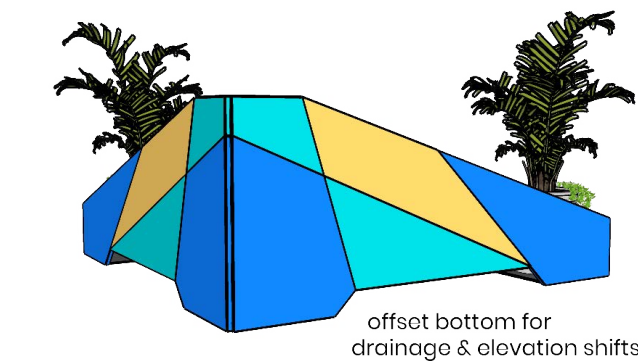

Wingin' It outer perspective

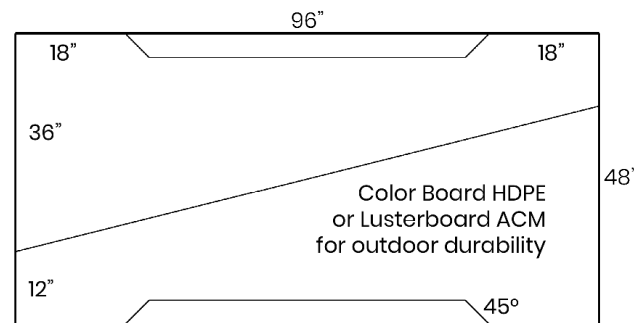

Wingin' It single sheet cuts plan

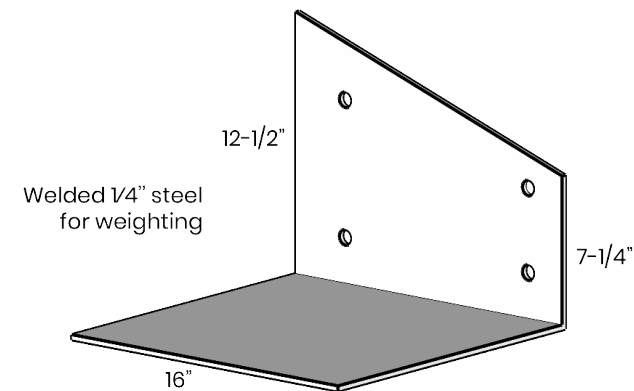

Wingin' It foot detail

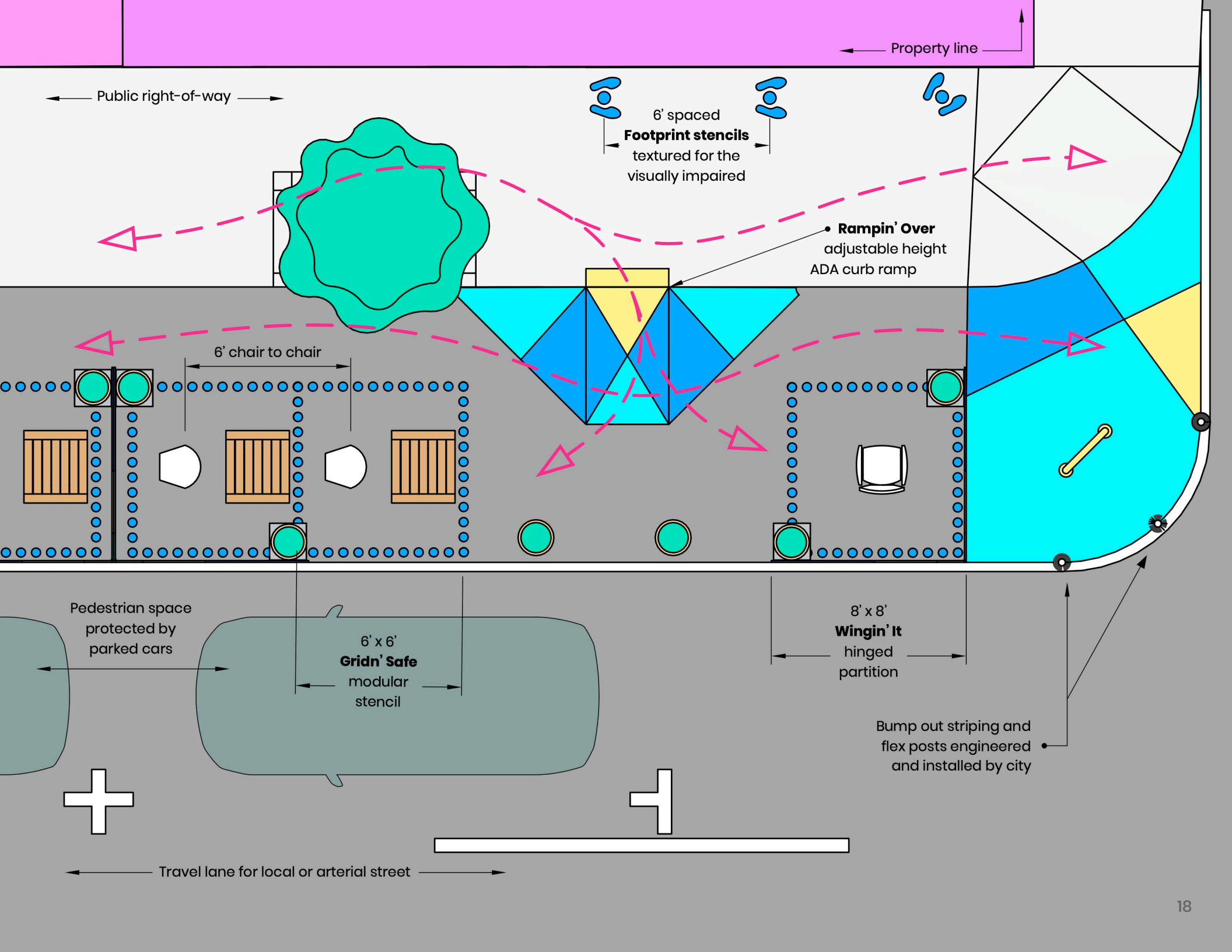

Find Your Tropical Island



Find Your Tropical Island

CHRISTOPHER ODUSANYA

A Community driven place making approach to physical distancing. Using a system of easy to find materials and objects. Together the community driven physical distancing performance plaza, tropical lounge gathering spaces and tropical market spaces are created to bring us back together.

Islands vary in size from 1' - 6' diameter circles with thought given to the activity level. A large social distancing performance stage sits in the center. The materials needed to create the islands are spray chalk, temporary paint or vinyl graphics. Sustainable reuse of materials such as old tires painted for seating, existing tables, umbrellas and shelving will be used for the market spaces and relaxed physical distancing gathering spaces.

All items are encouraged to be sourced locally within the community. Overall Find Your Tropical Island seeks to revive community and performance spaces by removing social distancing and encouraging physical distancing.

COST



MAINTENANCE

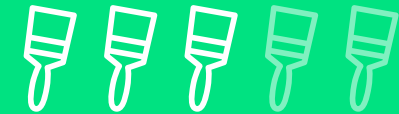

FABRICATION



MATERIALS

- **Umbrellas**
- **Native plants**
- **Planter**
- **Cleaned and painted used tires**
- **Hand sanitizer**
- **Spray chalk, paint, or vinyl**
- **Stencils**

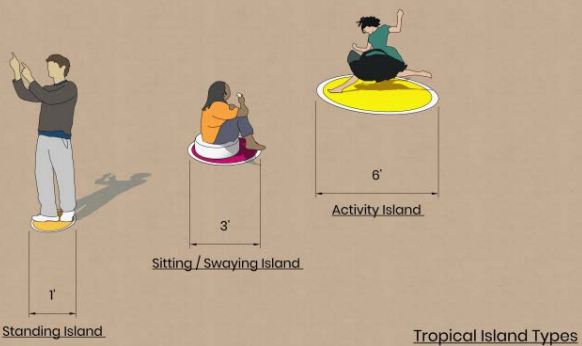
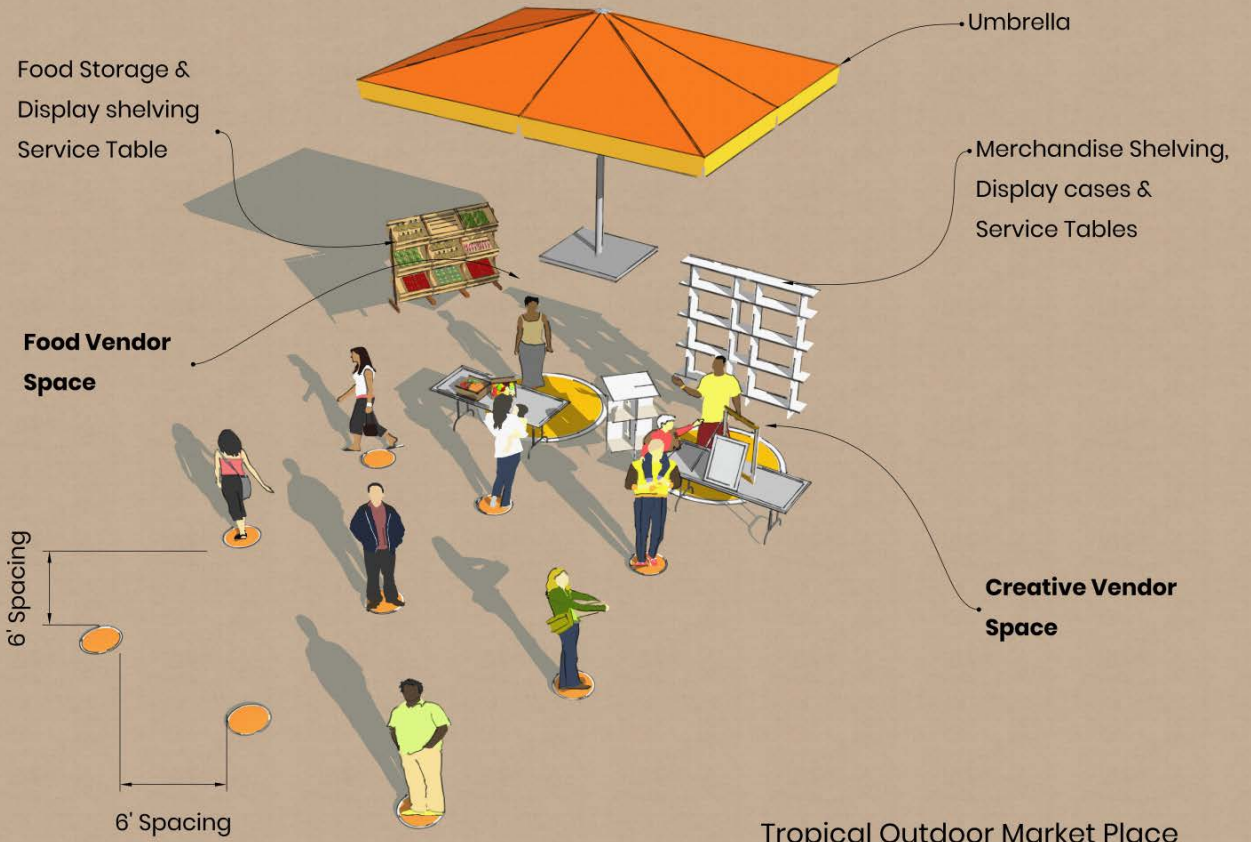
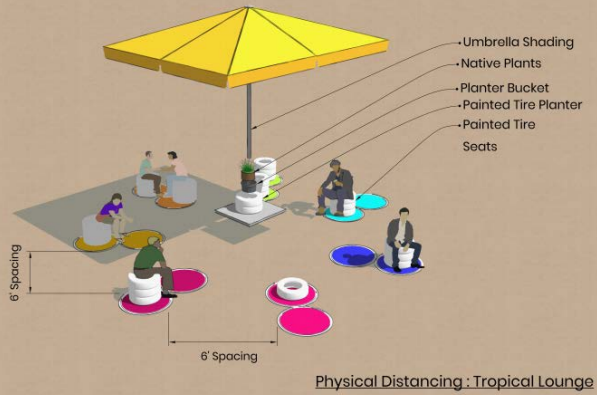
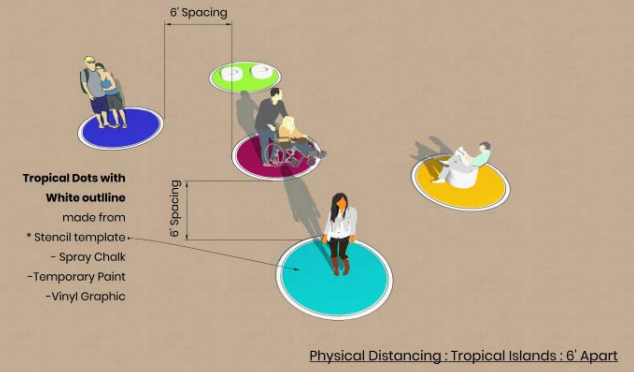
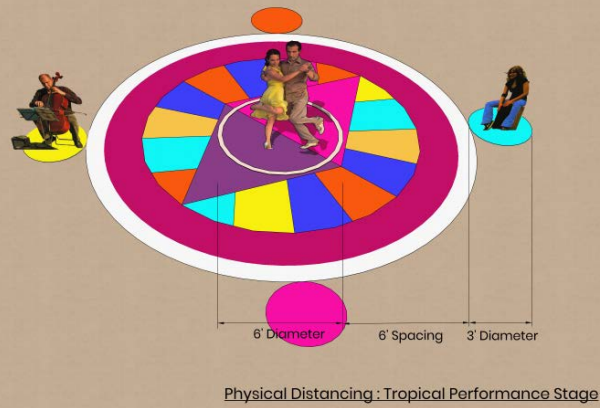

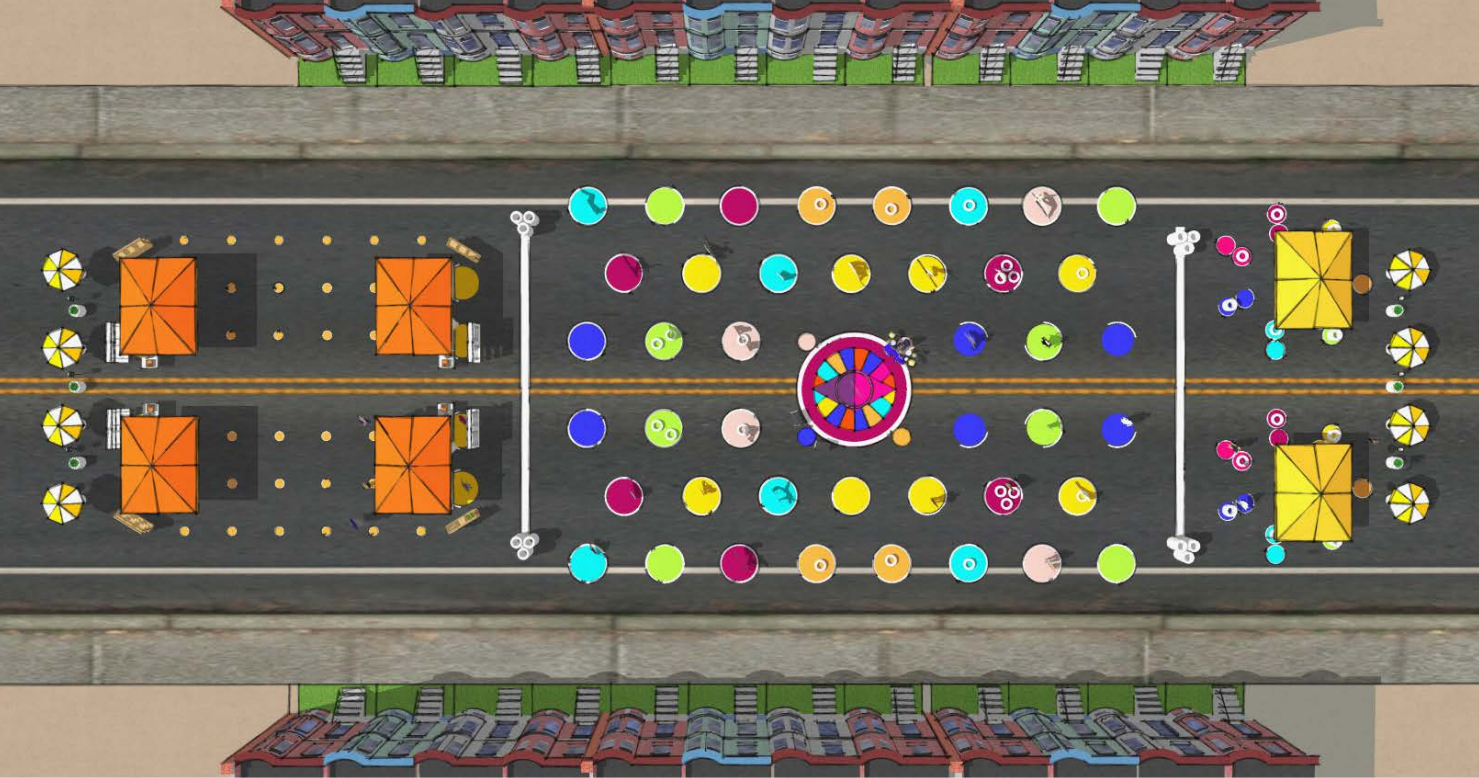

Block / Street Plan Scheme

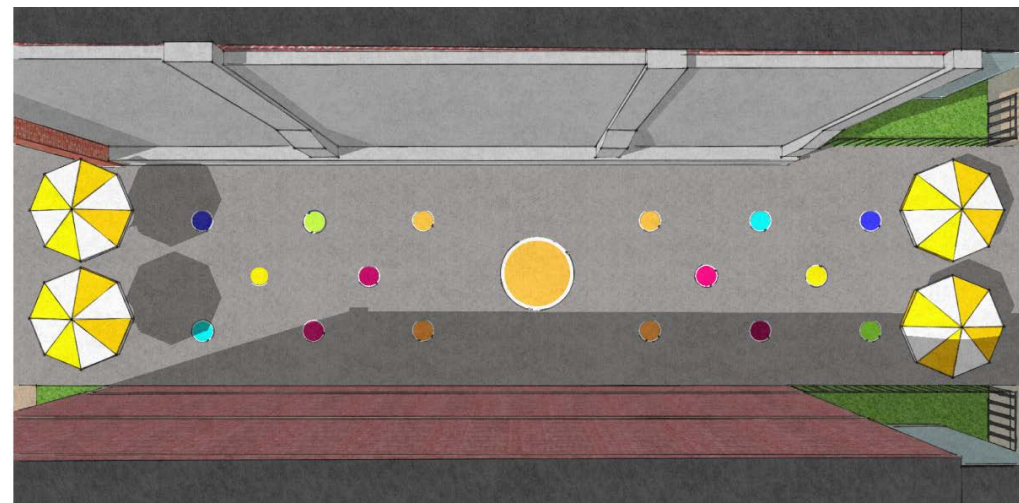
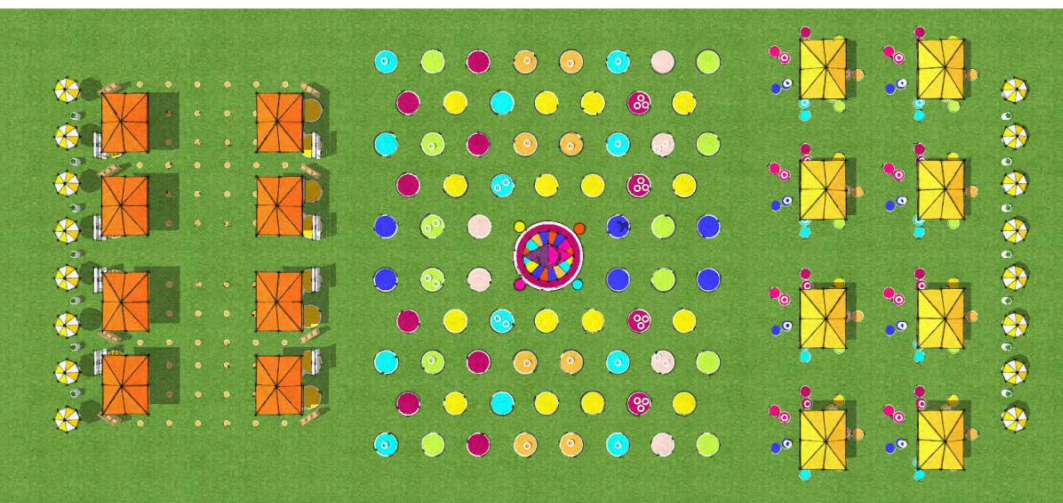

Park Plan Scheme

Alley Plan Scheme

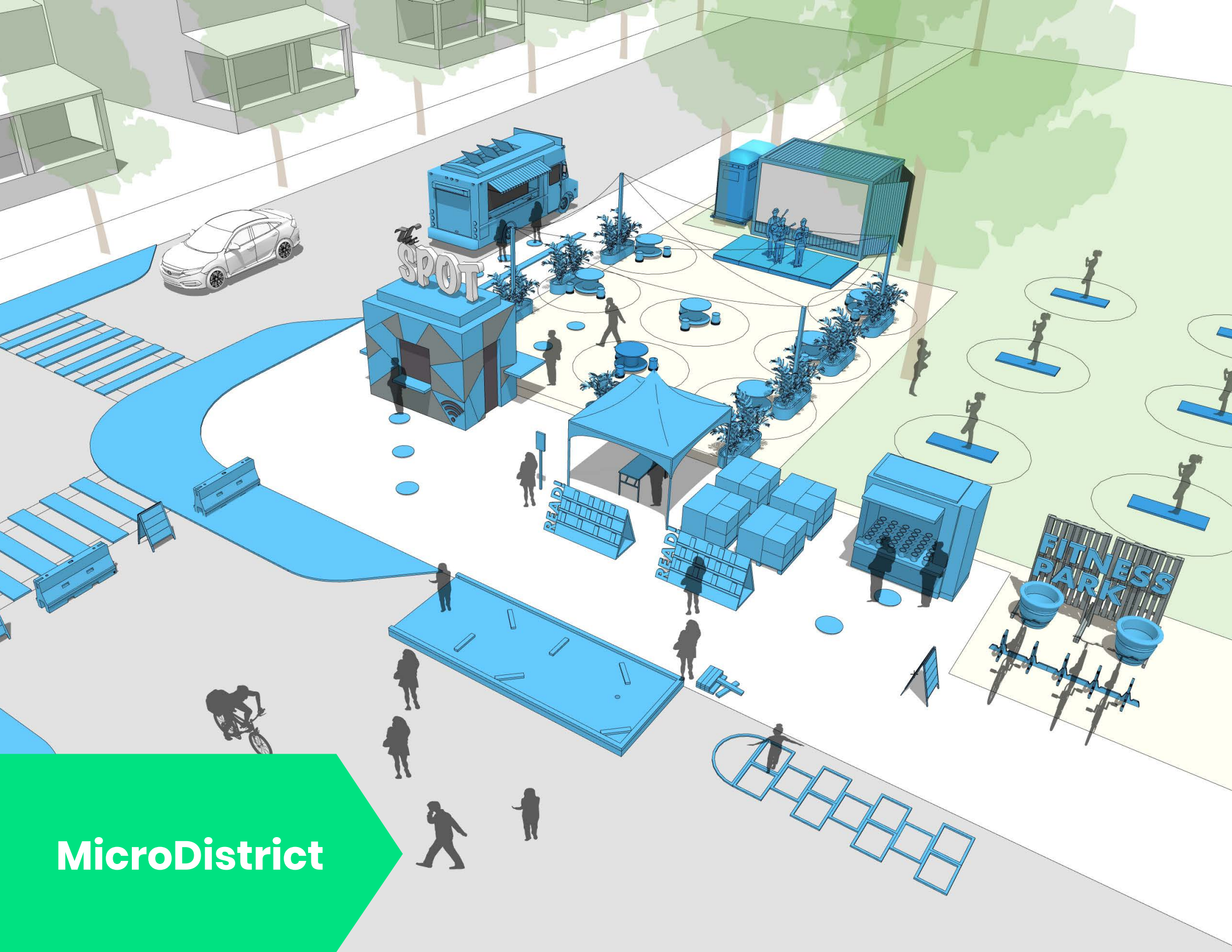

MicroDistrict

MicroDistrict

YARD & COMPANY, &ACCESS

JOE NICKOL, KEVIN WRIGHT, BOBBY BOONE

The COVID-19 pandemic has exacerbated the extent to which Black and brown communities have been unable to access essential amenities such as grocers, restaurants, and libraries. In these hardest-hit communities, residents are forced to venture outside of their immediate neighborhood for basic necessities.

Additionally, because of complicated and cumbersome application processes, and the reluctance of outside visitors to patronize businesses in under-served neighborhoods, minority-serving businesses have been historically unable to bridge the access gap or experiment with operating in the public.

COVID-19, though, offers a unique opportunity to change the narrative and embrace new opportunities that celebrate cultural diversity and entrepreneurship in neighborhoods often left out of the conversation. MicroDistrict is the solution: a staffed pop-up hub and neighborhood anchor that safely and enjoyably meets neighborhood needs through a variety of functions, including, but not limited to, kids' activities, health checks, food trucks and mobile pantries, haircuts, art, mobile libraries, and internet access.

COST



MAINTENANCE



FABRICATION



MATERIALS

- **Spray chalk and surface paints**
- **Repurposed shipping container and/or used kiosks**
- **Cable spools**
- **5 gallon buckets**
- **Plywood**
- **Planters**
- **String lighting**
- **Wood pallets**
- **Stencils**
- **Bike rack(s)**

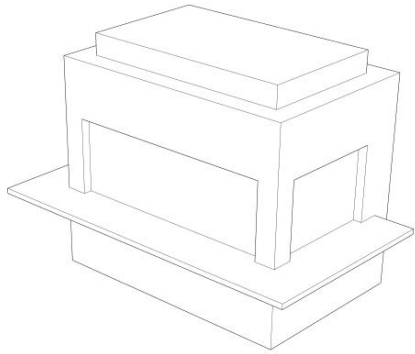

Kiosk / Concessions Trailer [\$3,000 - \$7,500]

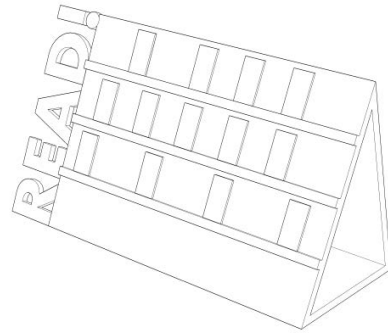

Library Stand [\$100 - \$500]

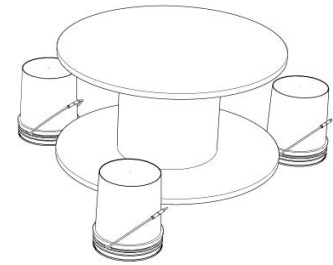

Spool + Bucket Seating [\$15 plus donated spoils]

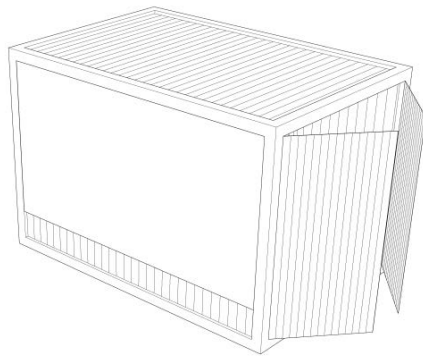

Screen + Storage [\$1,400 - \$2,000 delivered]

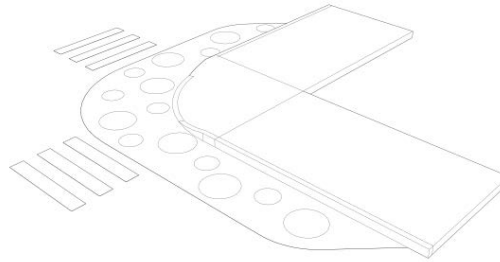

Painted Bumpouts and Crosswalks [\$750 - \$2,000]

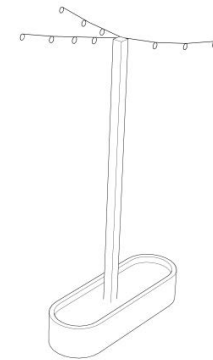

Lighting + Planter Trough [\$150 per stand]

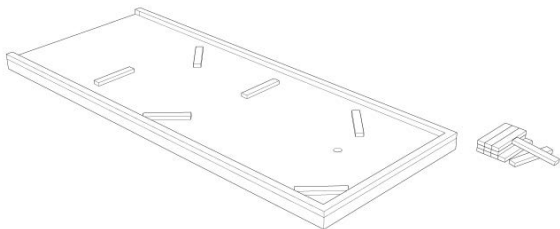

Spatially Distanced Games [\$25 - \$300 apiece]

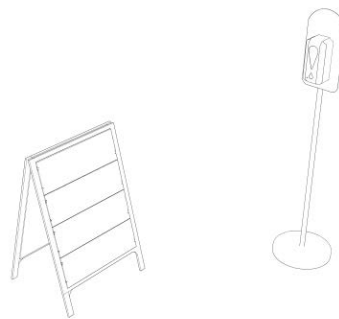

Sanitation Stand and Signage [\$300 - \$500]

Core Controlled Site Area
[5,000 to 10,000 sf]

Queuing Stencils
[6 ft on center]

Marked Public Spacing Circles
[12-16 ft diameter with 3-5 ft spacing]

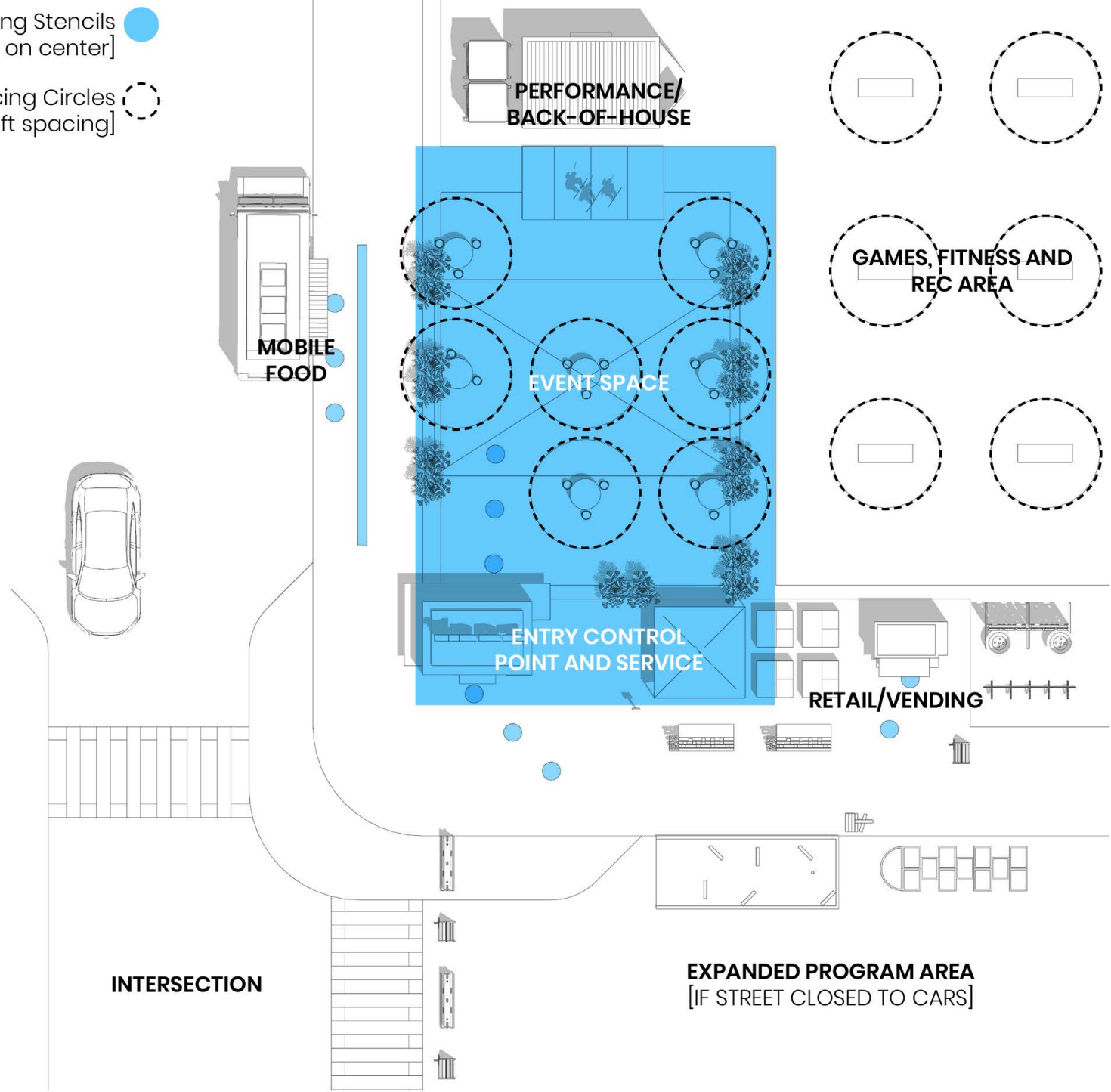

PHYSICAL DISTANCING SIGNAGE

HANDS-FREE DOOR HARDWARE

24" DIAMETER PTD CIRCLE @ 8'-0" O.C., STENCILED W/ TEXT TO READ, "STAY A DOT AWAY" EVERY THIRD CIRCLE, TEXT FACING DIRECTION OF TRAVEL & STAGGERED W/ OPPOSITE DIRECTION OF TRAVEL

OPTIONAL ADDITIONAL HANDWASHING STATION(S)

HANDWASHING STATION

HANDWASHING SIGNAGE

SIDEWALK

PARKING LANE

STREET

Hygiene,
Hon

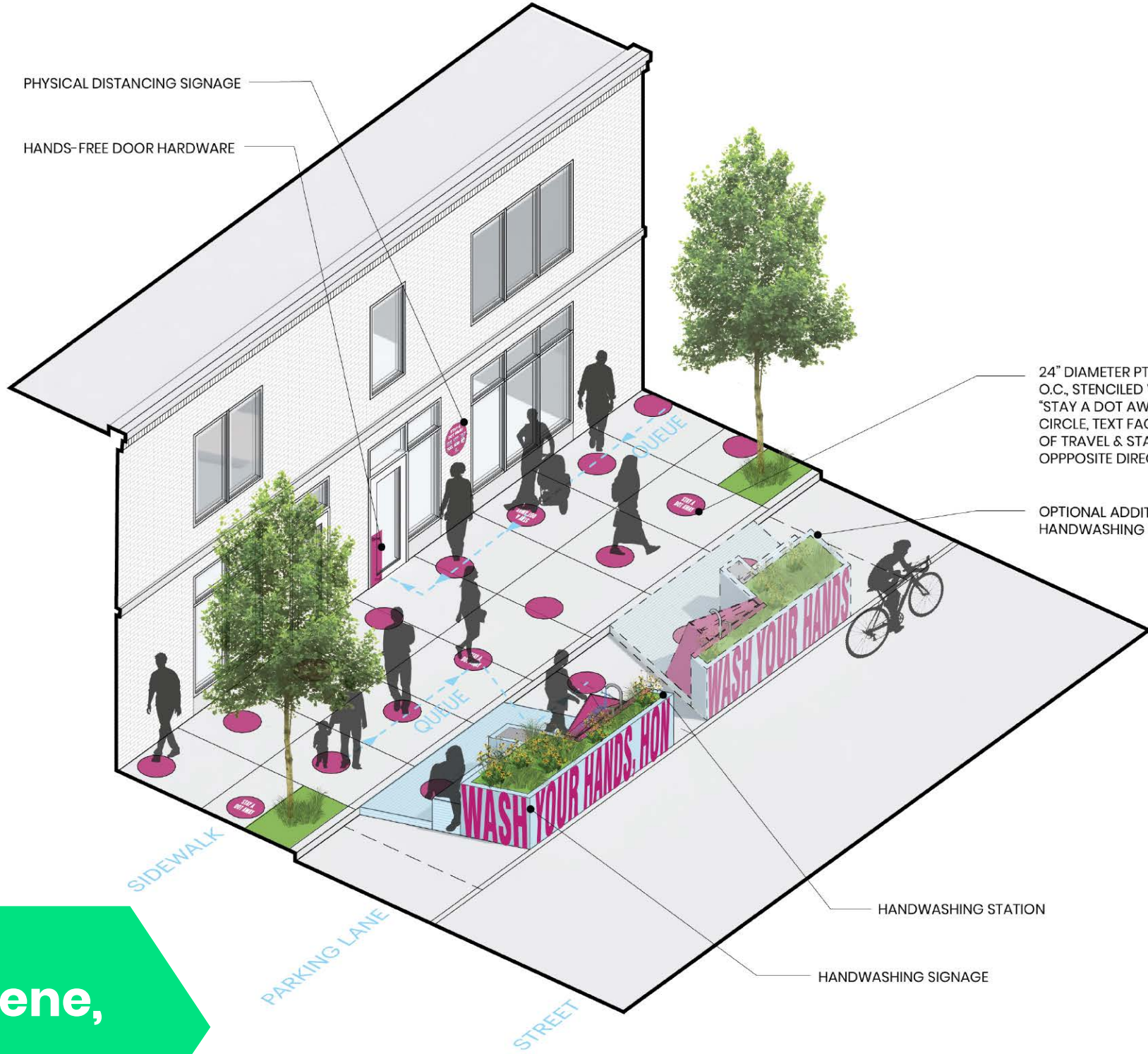

Hygiene, Hon

ZIGER|SNEAD ARCHITECTS

DOUG BOTHNER, JEREMY CHINNIS, CYRUS LEE, KELLY DANZ

Hygiene, Hon provides a framework for the re-opening of urban businesses and details several methods to enable and emphasize physical distancing and effective hand hygiene.

1. Modular handwashing stations are equipped with a water reservoir and foot pedal for hands-free operation. Waste water is filtered and collected as irrigation for adjacent planters. The stations can be installed individually or block-wide, and nest when grouped, creating a network of handwashing stations and physically distanced seating.
2. Graphics and signage demonstrate appropriate physical distances for queuing and traversing, handwashing techniques, and other recommendations, using colored markers along the sidewalk, building façades, at doors, and at handwashing stations.
3. Adaptive door hardware allows the public to limit contact with highly-touched surfaces. Small modifications to existing doors allow hands-free operation.

The project aims at reducing disease transmission by utilizing visual and spatial representations of national health recommendations in the public realm.

COST



MAINTENANCE



FABRICATION



MATERIALS

- Wood or composite decking
- Steel tube framing
- Sink and plumbing components
- High density fiberboard (HDF)
- Soil and native plantings
- Hands-free foot pull
- Hands-free door/lever pull
- Paint
- Stencils
- Vinyl signage

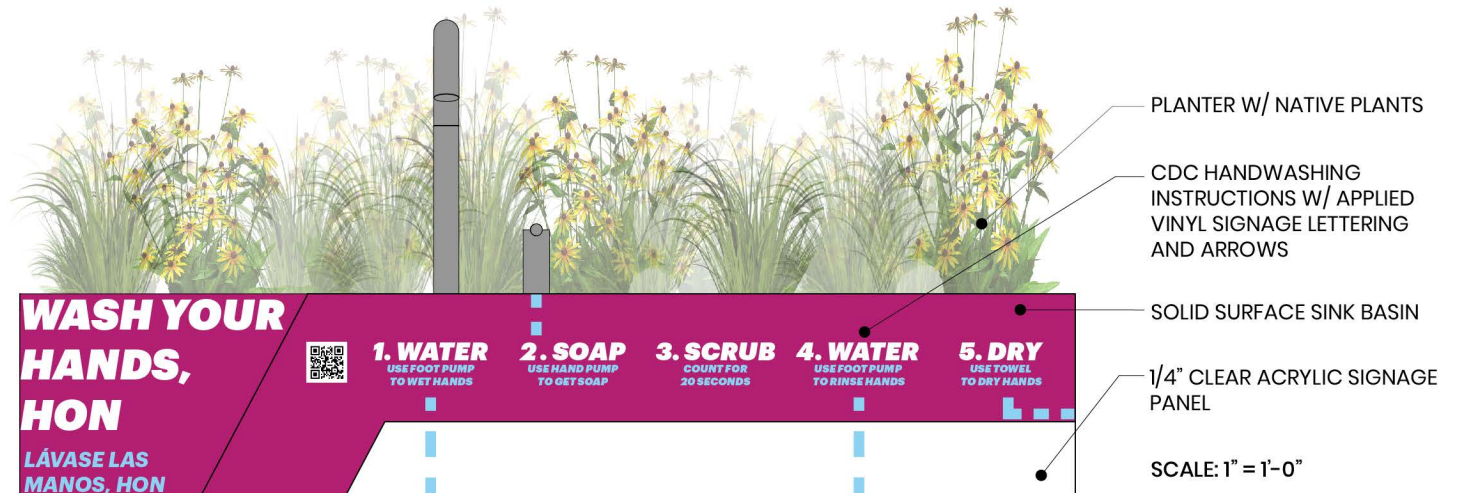
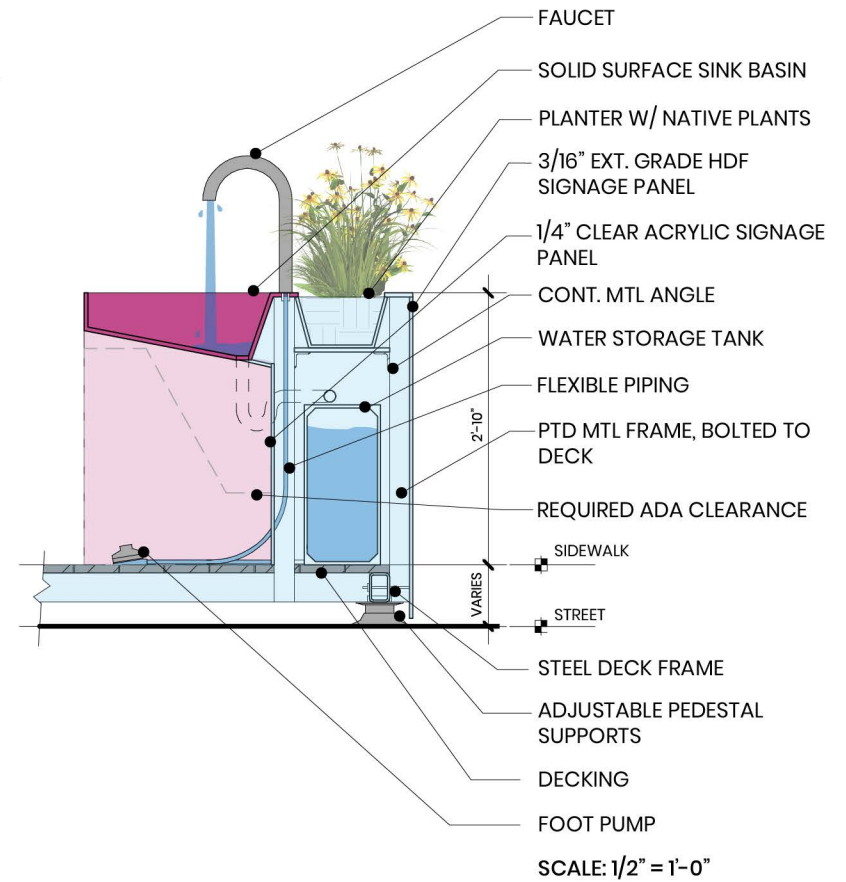
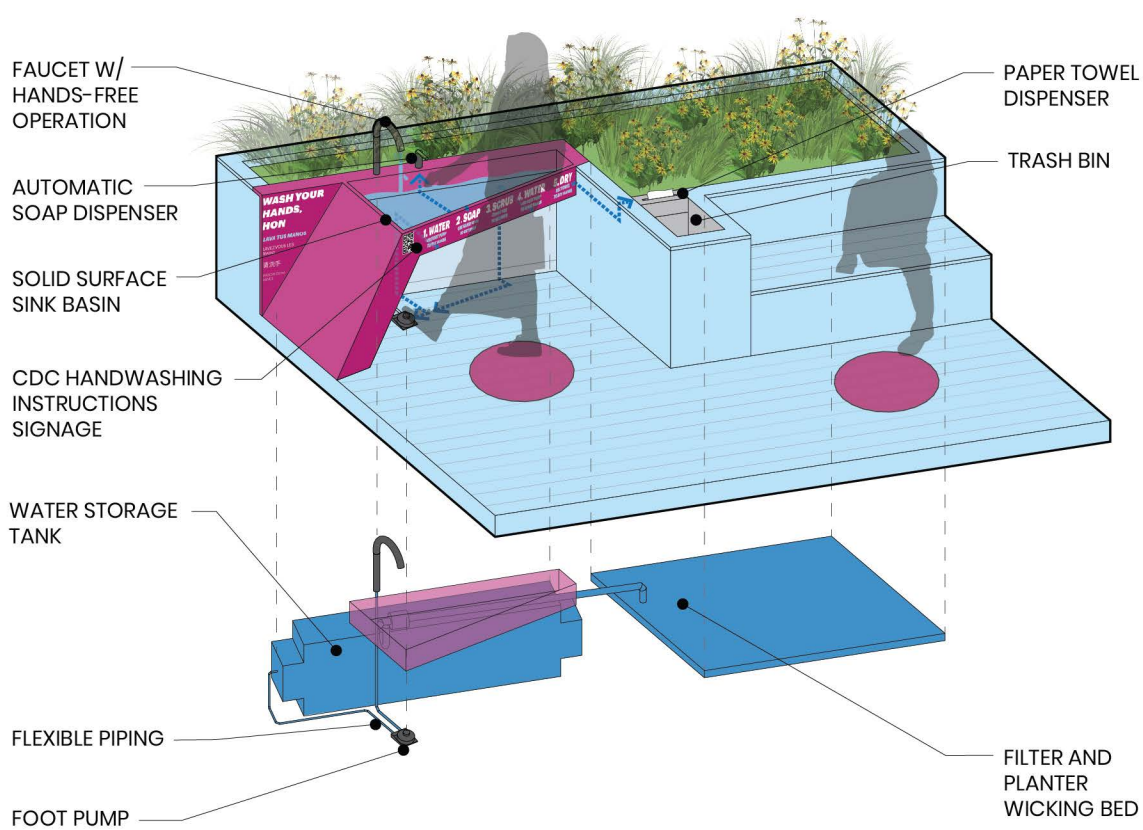

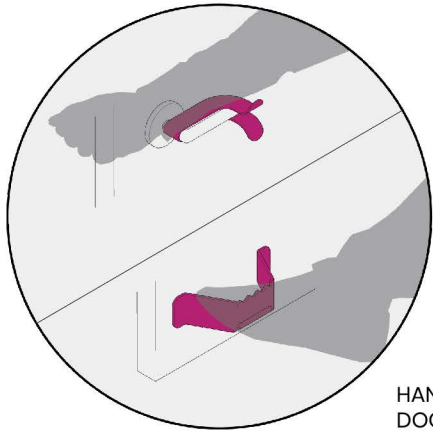

HANDS-FREE
DOOR
HARDWARE



PHYSICAL
DISTANCING
SIGNAGE

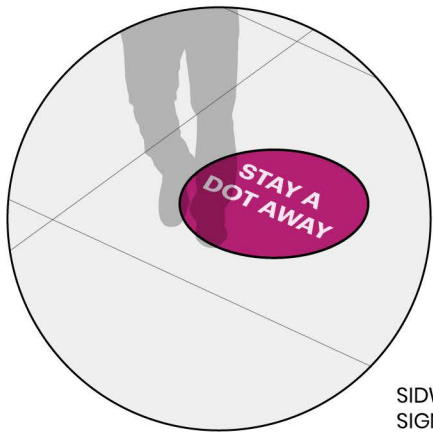

SIDWALK
SIGNAGE

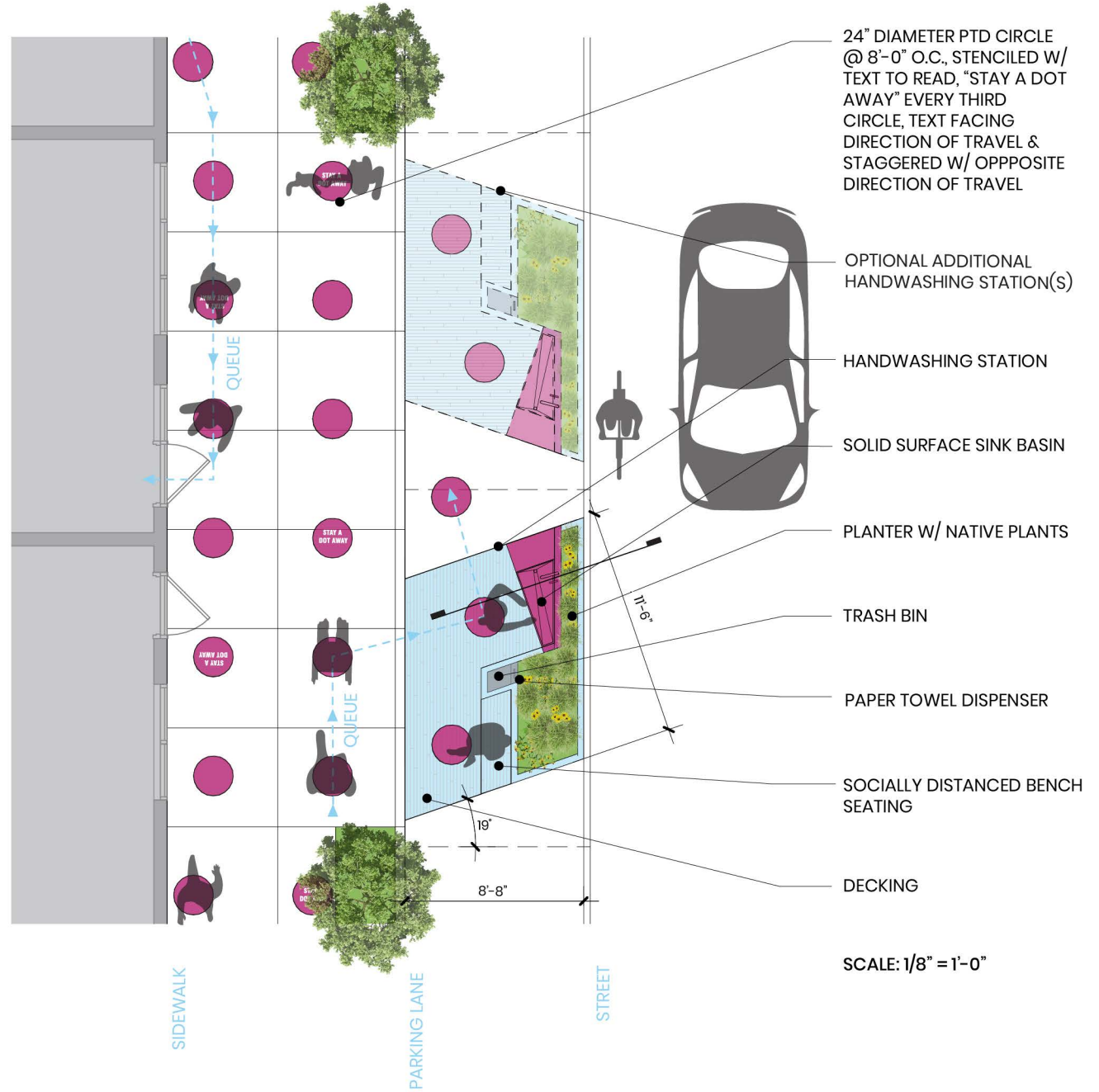

Organizing the Street

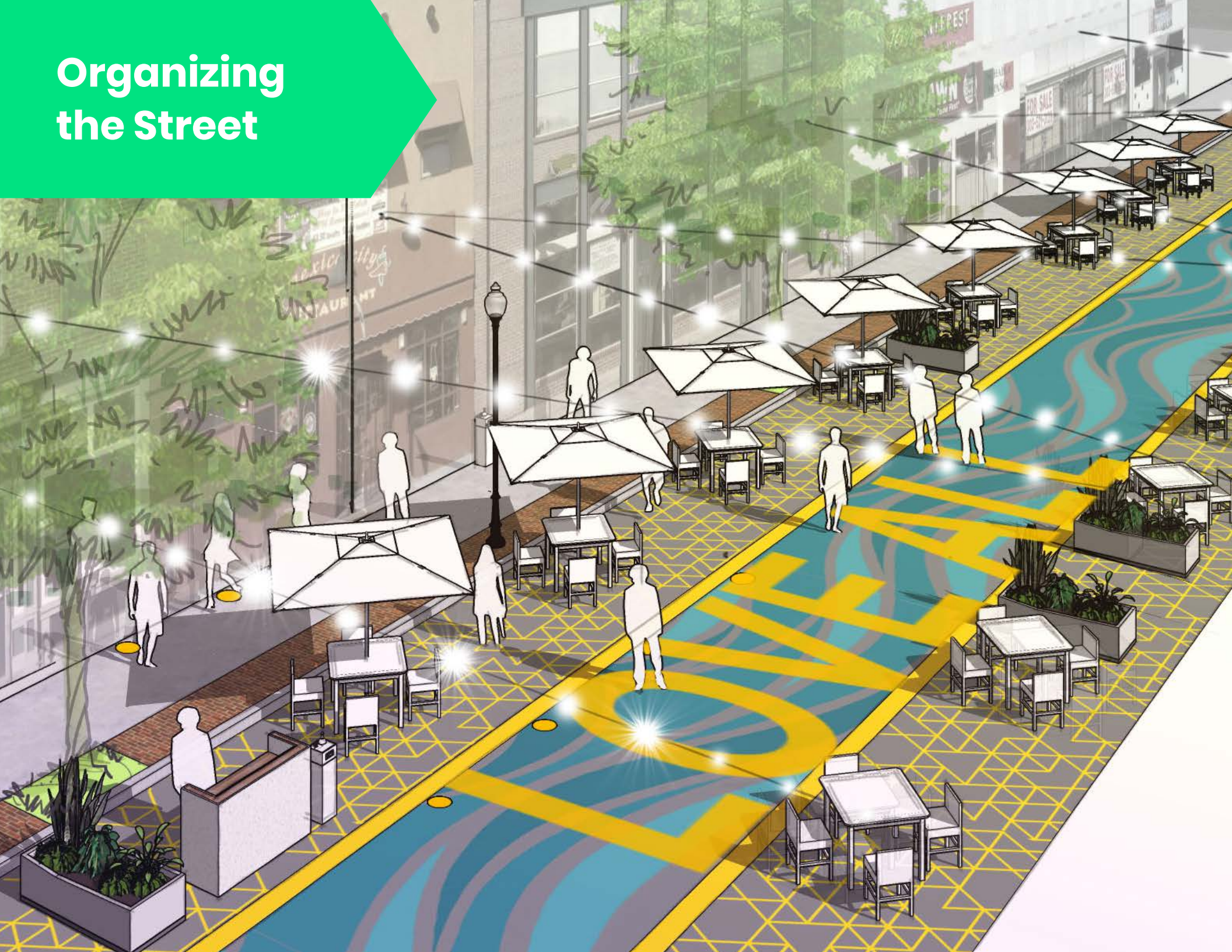

Organizing the Street

EDSA

CRAIG STONER, TERRI WU

This design helps to inform and organize streetscapes in dealing with social distancing guidelines. This design looks at how to adapt the public realm for closing streets, adding parklets in place of street parking and adding layers of human scale elements.

The closed street is organized to provide a promenade feel in the street, a dining zone and a curbside, business oriented zone. The street, with murals, graphics and patterns, takes over as the sidewalk allowing for ample social distancing. The outdoor dining zone integrates 6' spacing of tables, a hostess stand, sanitation stations and planters to separate adjacent businesses. The existing sidewalk zone, which can be very narrow across Baltimore city, is set off for direct interactions with businesses for curbside pickup or waiting for indoor service.

Streetscapes and parklets adjacent to active streets are organized in a similar fashion with street parking being used for outdoor dining. The existing sidewalks include specific locations for curbside pickup and general pedestrian flow. The outdoor dining is created with barriers to provide patrons a safer environment to dine while adjacent to traffic.

COST



MAINTENANCE



FABRICATION



MATERIALS

- **String lighting**
- **Planters**
- **Road paint**
- **Road tape**
- **Barricades**
- **Wood pallets**
- **Dining furniture (to be provided by restaurants)**
- **Hand sanitizer**

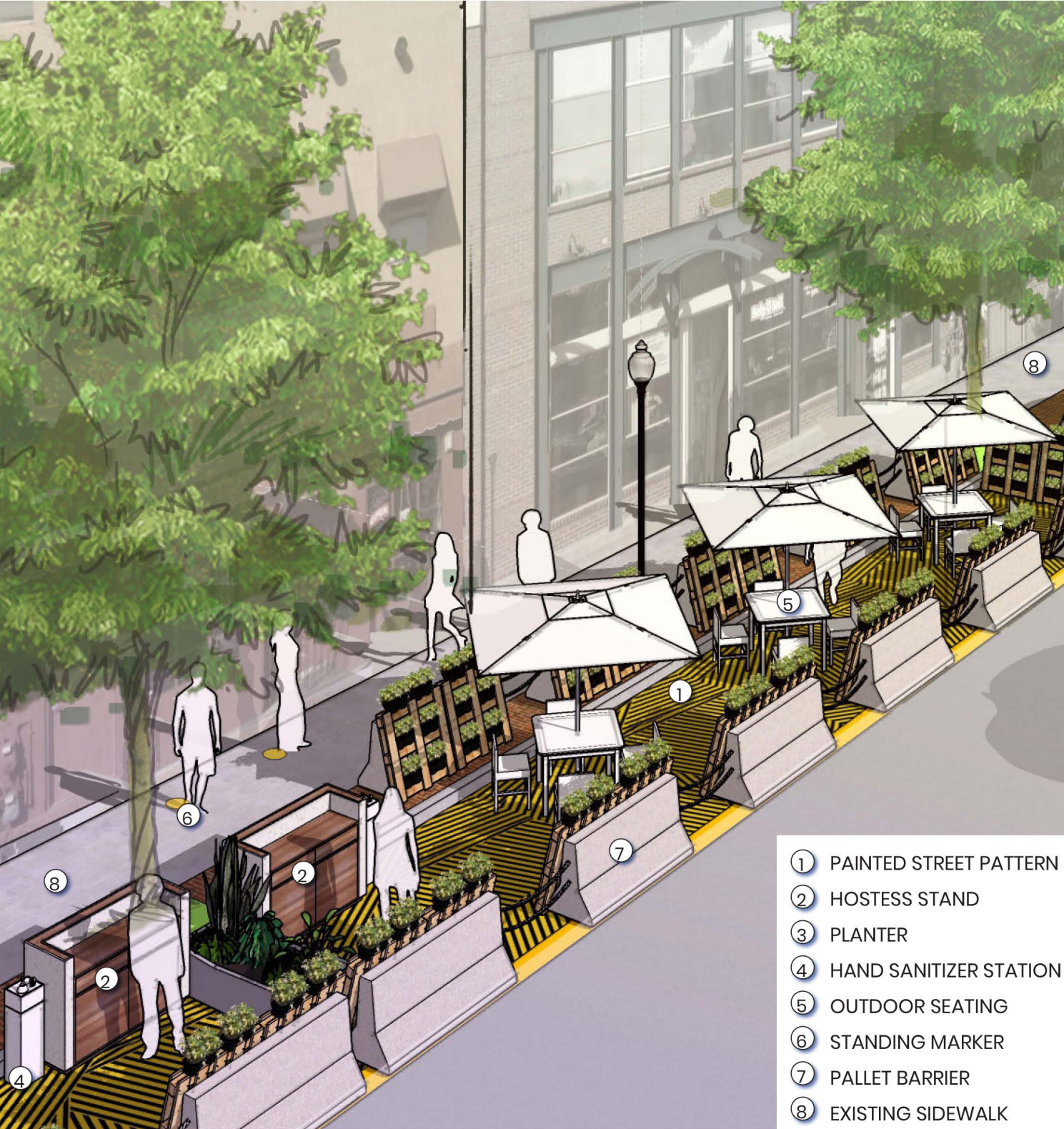

- ① PAINTED STREET PATTERN
- ② HOSTESS STAND
- ③ PALLET BARRIER
- ④ HAND SANITIZER STATION
- ⑤ OUTDOOR SEATING
- ⑥ STANDING MARKER
- ⑦ PALLET BARRIER
- ⑧ EXISTING SIDEWALK



PLANTS PLACED WITHIN PALLET STRUCTURE



PLANTS CLIPPED OR HOOKED TO PALLET STRUCTURE

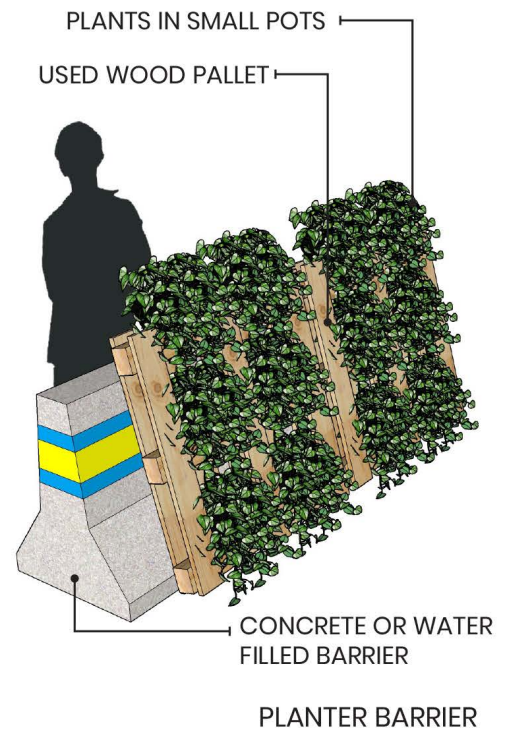



LOVE ALL

LOVE ALL

004
003
002
001

056

052

058 34

014
015
016

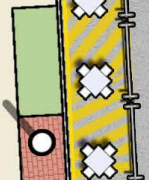
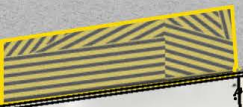



RETAIL CIRCULATION
GROUND SURFACE TREATMENT

MAIN CIRCULATION LIGHTING

MAIN CIRCULATION
GROUND SURFACE TREATMENT

ENTRY LIGHTING

SANITIZING STATION

**inFRONT
of House**

inFRONT of House

PI.KL

PAVLINA ILIEVA, KUO PAO LIAN, BRIAN BAKSA, ESTHER CHO

The return to social interaction is an opportunity to re-envision open shared space in the context of small-business food/retail/service operations that shape urban experiences and promote local economies.

inFront of House proposes a framework of spatial components right outside a place of business, effectively redistributing the previous front-of-house into the streetscape. Acting as a continuous extension of the sidewalk, a level platform occupies the zone typically dedicated to parking and provides additional space for physical distancing while enabling business use and social interaction. The previous front-of-business becomes an auxiliary entry for service and pick-up, shifting focus to the newly created outdoor space. Planters/canopies/movable shelving/ demarcate the new zones while strategic lighting components and ground surface treatment reinforce new movement patterns.

inFront of House introduces interventions that look and feel 'normal', offering an evolution to public space not branded by the pandemic but rather by celebration of urban social lifestyle.

COST



MAINTENANCE



FABRICATION



MATERIALS

- Composite wood decking
- Aluminum profile
- White sail fabric
- Scaffolding
- Planters
- Plants and soil
- Metal shelving
- Casters
- Fasteners
- Lighting

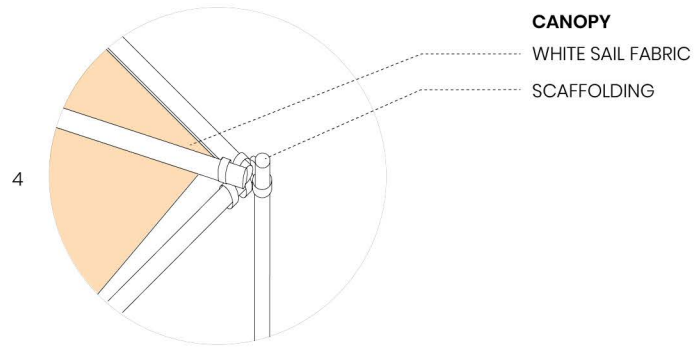
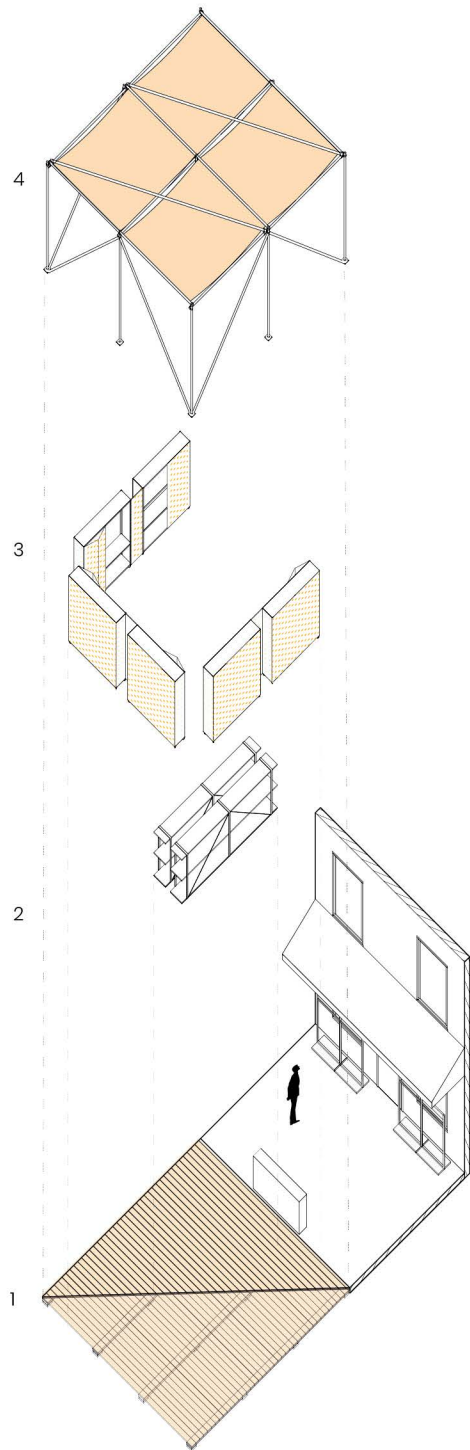

CANOPY

WHITE SAIL FABRIC

SCAFFOLDING

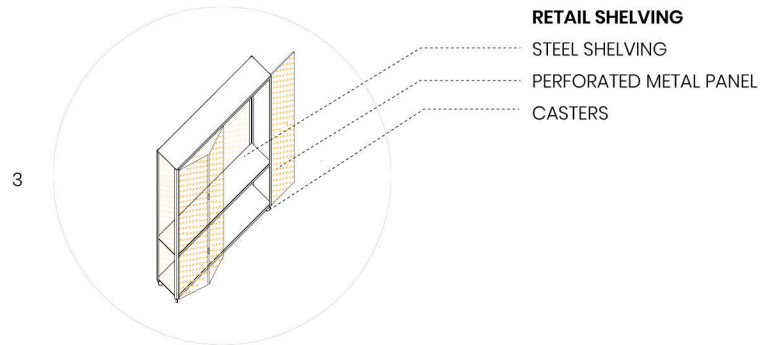

RETAIL SHELVING

STEEL SHELVING

PERFORATED METAL PANEL

CASTERS

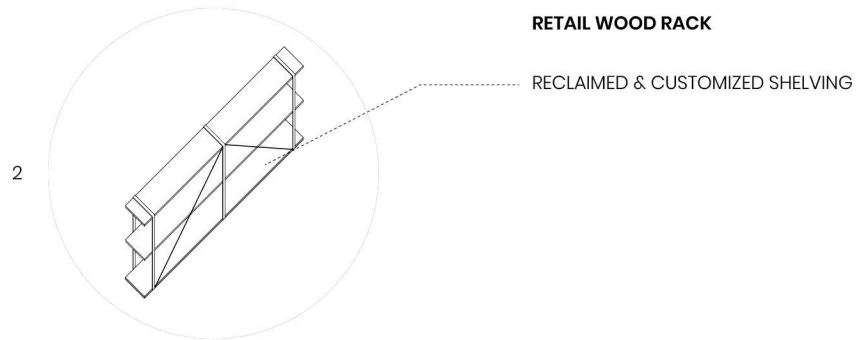

RETAIL WOOD RACK

RECLAIMED & CUSTOMIZED SHELVING

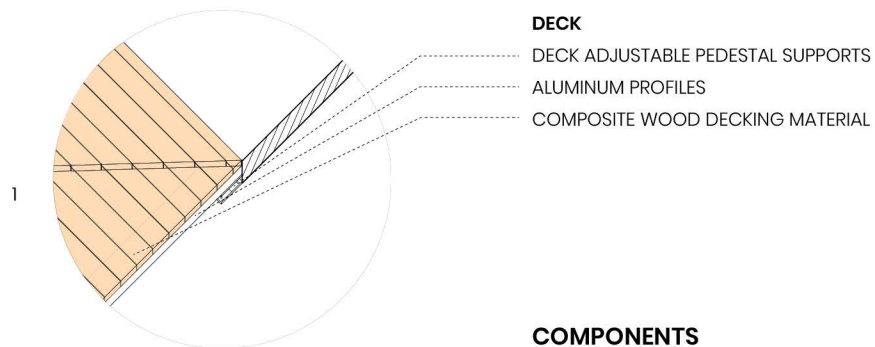

DECK

DECK ADJUSTABLE PEDESTAL SUPPORTS

ALUMINUM PROFILES

COMPOSITE WOOD DECKING MATERIAL

COMPONENTS

REMOVE
VEHICULAR
TRAFFIC

CONVERT PARKING
TO EXTERIOR
SEATING, SERVICE & RETAIL

WAITING
QUEUING
ENTRANCE
HOST
POS

6' MIN MAIN
CIRCULATION PATH
VARIES PER
SIDEWALK WIDTH

WAITING
DINING
PICK-UP
RETAIL
POS

SMALL
BUSINESS

PLANTER
SUPPLIES

PLANTER
SUPPLIES

PLANTER
RETAIL

PLANTER
MASK ZONE
WAITING

PLANTER
MASK ZONE
WAITING

PLANTER

SERVICE

PLANTER

MASK ZONE

PLANTER
MASK ZONE
WAITING

PLANTER
MASK ZONE
WAITING

DINING

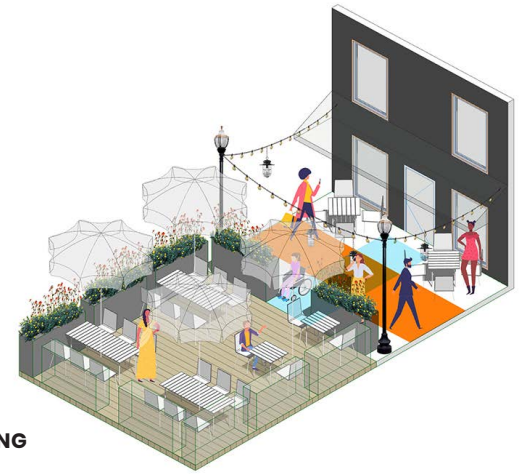

PLANTER

SUPPLIES

PLANTER

SUPPLIES

PLANTER

RETAIL

PLANTER
POS

PLANTER
MASK ZONE
WAITING

PLANTER
MASK ZONE
WAITING

CAFE/
RESTUARANT/
BAR

PLANTER

PLANTER

PLANTER

PLANTER
MASK ZONE
WAITING

PLANTER
MASK ZONE
WAITING

LEVEL WOOD
DECK IN PLACE
OF PARKING FOR
ADA ACCESSIBILITY

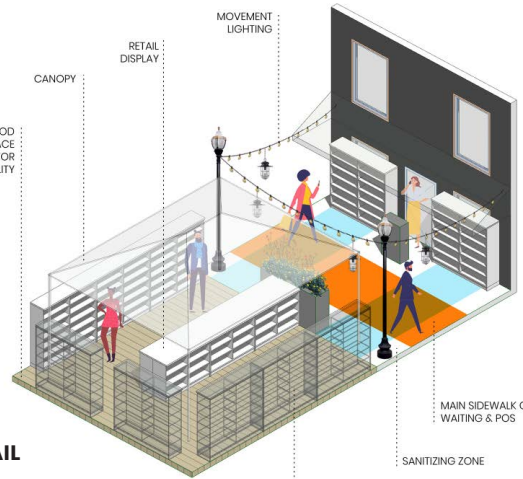

PLANTER

MASK ZONE

PLANTER
H

PLANTER
MASK ZONE
WAITING

PLANTER
MASK ZONE
WAITING

RETAIL

PLANTER

RETAIL

PLANTER

RETAIL

PLANTER

RETAIL

PLANTER
ENTER

PLANTER
MASK ZONE
WAITING

PLANTER
MASK ZONE
WAITING

RETAIL

RETAIL

MASK ZONE

PLANTER
ENTER

PLANTER
MASK ZONE
WAITING

PLANTER
MASK ZONE
WAITING

SERVICE

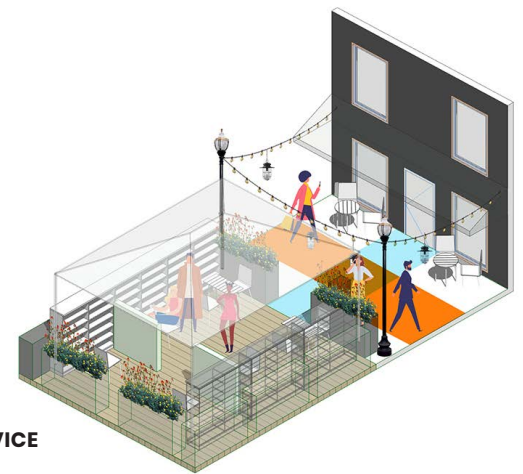

RETAIL

RETAIL

RETAIL

RETAIL

RETAIL

RETAIL

PLANTER
EXIT

PLANTER
MASK ZONE
WAITING

PLANTER
MASK ZONE
WAITING

SMALL
BUSINESS

RETAIL

MASK ZONE

PLANTER
EXIT

PLANTER
MASK ZONE
WAITING

PLANTER
MASK ZONE
WAITING

RETAIL

RETAIL

RETAIL

PLANTER



Make ApART

Make ApART

QUINN EVANS

ETHAN MARCHANT, STEVE SCHWENK

SITE & PROGRAM: This proposal, in a vacant lot across the street from Creative Alliance in Highlandtown, provides a physically safe, collectively social venue that brings diverse groups together using art classes, performances and other encounters. The space is demarcated by shipping containers at each corner that provide art storage, concessions, retail, or restrooms.

MODULE: The site is subdivided by an 11x12 ft grid of 'modules' accommodating groups of 4-6 people while providing recommended distance from other attendees. Colored light poles highlight each individual module while alternating ground floor textures provide an individualized, rich urban carpet on the ground. Shown here as a site-specific collective, the modules are intended to be installed in alternate urban spaces.

NUCLEUS: At the heart of each module is the "flip-flop-table-top." This table, with a rotating top, allows customized visitor experiences based on desired social grouping, creative activity or sense of personal space.

COST



MAINTENANCE

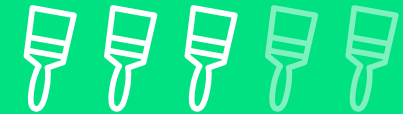

FABRICATION



MATERIALS

- Repurposed shipping container(s)
- Steel framing
- Wood decking and sheets
- Adjustable feet
- Solar powered lighting
- Spray paint
- Stencils
- Gravel, if needed



painted sidewalk grid:
for queuing or passerbys

concessions & art storage:
modified shipping containers

11x12 deck module:
can be implemented off site as prototype module

gravel module:
site specific to address topograpahy & drainage

circulation:
(2) zones to encourage physical separation

retail / supplies:
modified shipping container

storage / potential restrooms:
modified shipping container

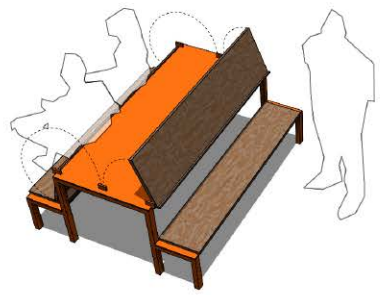
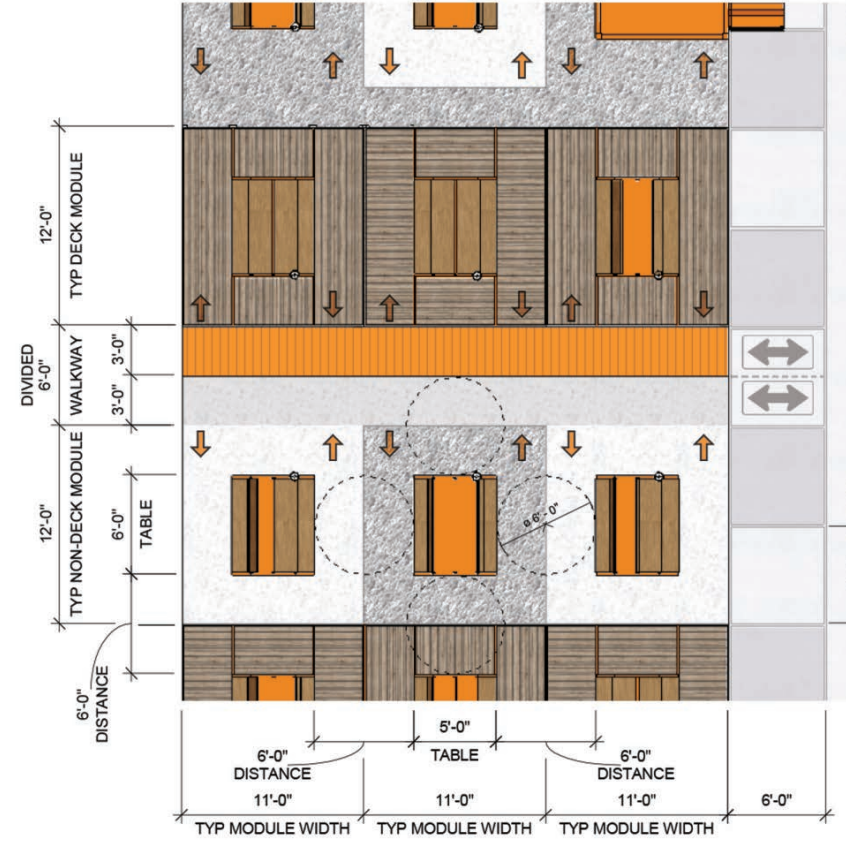

bench back | easel

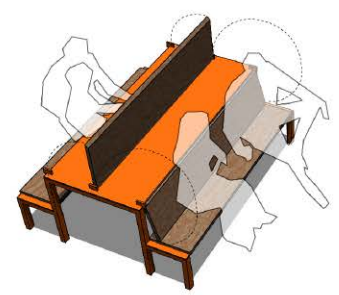

divider | bench back

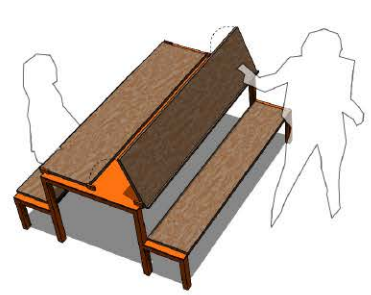

table | easel

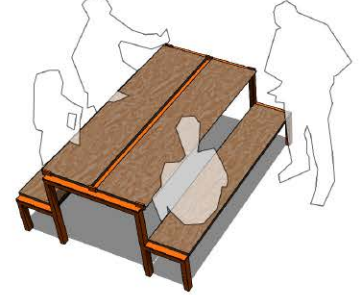
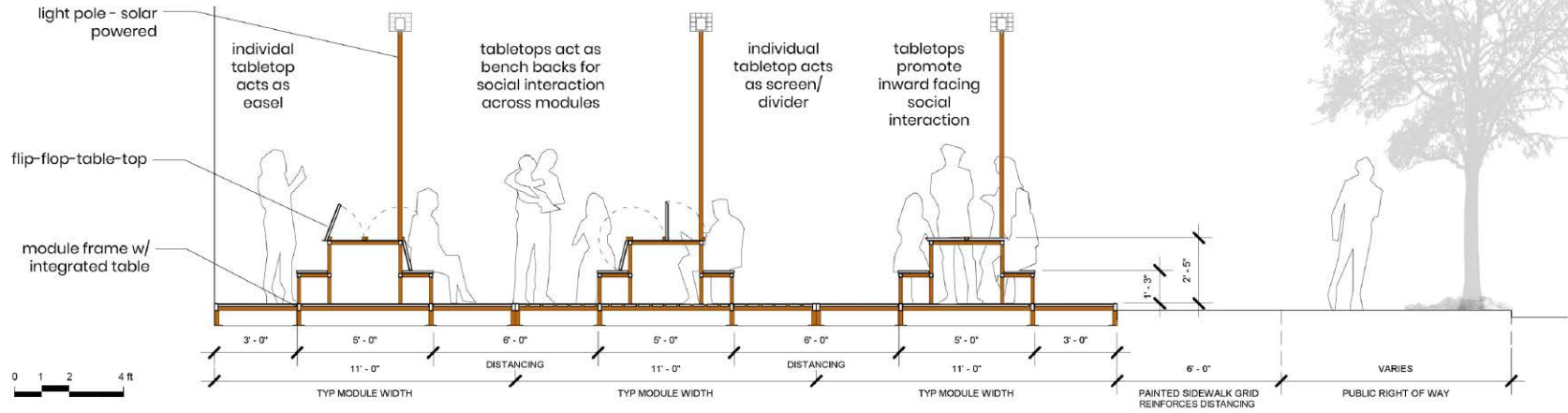
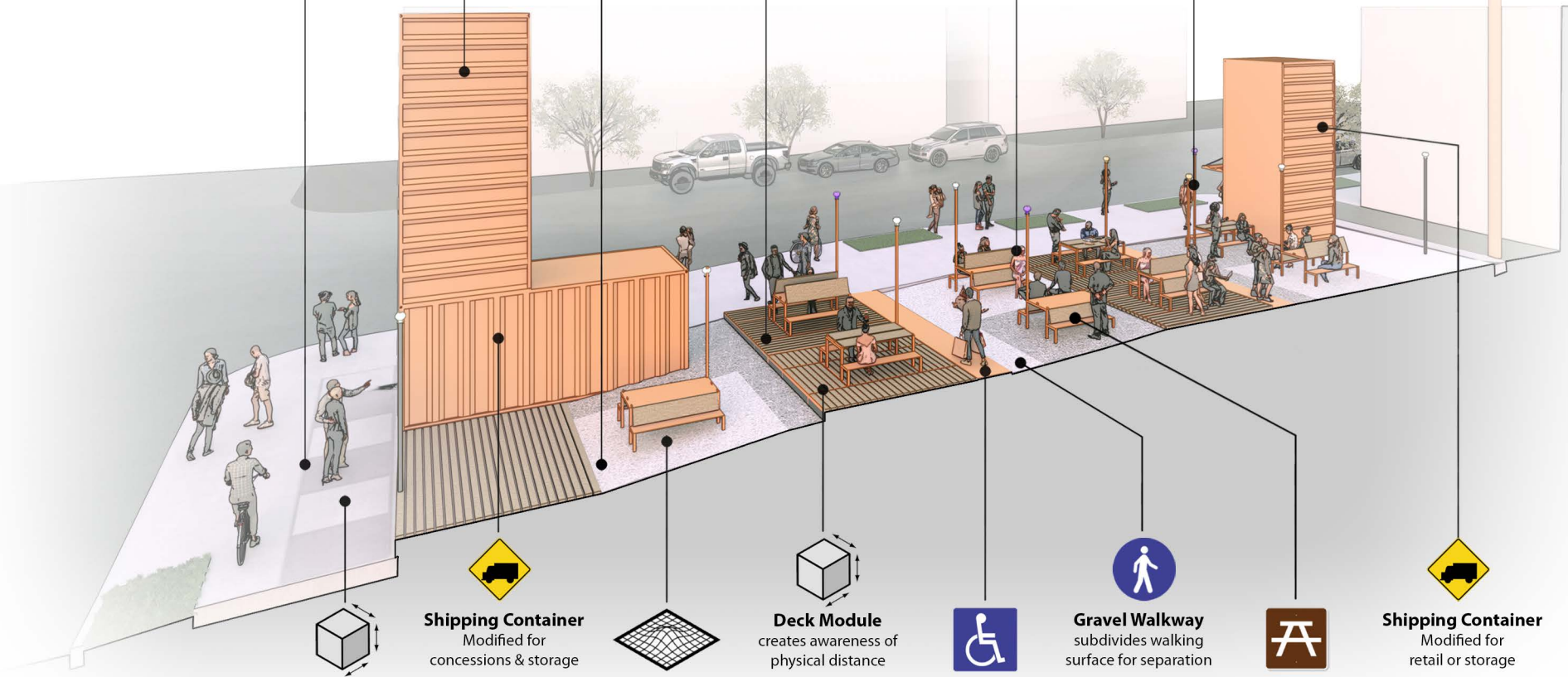

table | table



- Sidewalk Grid**
Spray Paint Stencil
- Shipping Containers**
(4) 20ft Units
- Site Grading**
Only as Required
- Wood Deck Module**
(8) 11x12ft Units
Treated Lumber, Steel Frame, Adjustable Feet
- Flip-Flop-Table-Top**
(14) Adaptable Units.
Steel Tube Frame, Treated Wood
- Post Lighting**
Color LED Bulb, Battery, Solar Panel



- Sidewalk Grid**
extends awareness for queuing and passers by
- Shipping Container**
Modified for concessions & storage
- Open Module**
allows deck modules to adjust to existing materials & topography
- Deck Module**
creates awareness of physical distance
- Accessible Walkway**
on wood deck
- Gravel Walkway**
subdivides walking surface for separation
- Flip Flop Table Top**
Fixed table with flexibility to adapt to social setting
- Shipping Container**
Modified for retail or storage

Space Frame

FOOD PICKUP

Takeout counter

Plexiglass partition with cutout windows reduces germ spread at the take out counter

Hand sanitizing

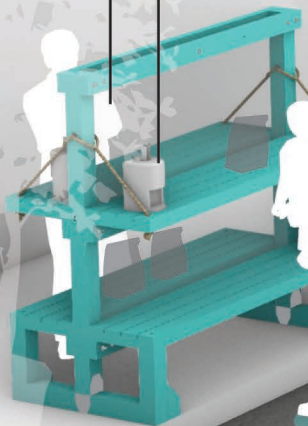

DINING

Partitions

Partitions can be used as signage to remind people to stay safe and follow guidelines

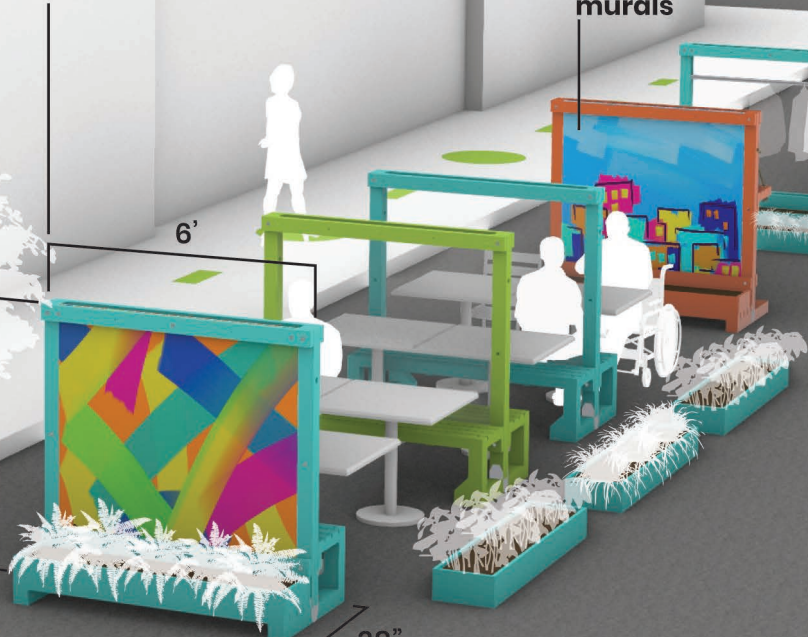

RETAIL

Painted murals

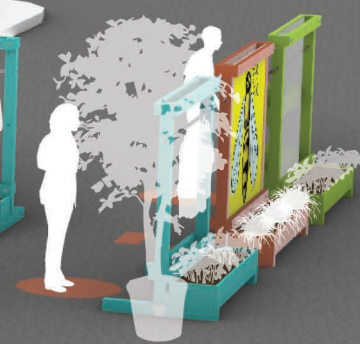

Markings
6' apart

6'

6'

38"

Space Frame

ZOE ROANE-HOPKINS

Space Frame's modular, multi-functional design aims to support socially engaging spaces while encouraging physical distancing. Components are easily attached with bolts and screws, or simply rest on the frame to create active, outdoor spaces for restaurants, retail, and entertainment.

Eating areas can be separated with plexiglass partitions while a standing counter with a half partition allows for safe and easy food pickup.

Retail stores can use the hanging rods, bar counters, and benches to display products and clothing. This customizability makes it easy to add hand sanitizing stations, educational signage, and incorporate other measures for physical distancing and hygienic habits.

Readily available materials like wood, paint, screws, and plexiglass make Space Frame a quick and colorful solution that can be part of any street plan.

COST



MAINTENANCE



FABRICATION



MATERIALS

- Pressure treated dimensional lumber
- 4x4 T brackets
- Bolts with washers and wing nuts
- Wood screws of various lengths
- Rope or chain
- Planter with soil and plants
- 6' steel pipe
- Plywood and/or plexiglass
- Exterior paint
- Hand sanitizer



TAKEOUT COUNTER

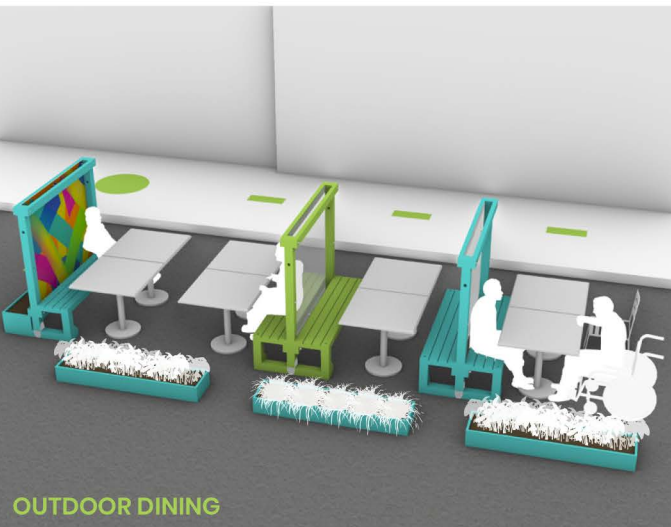

OUTDOOR DINING

FRAME COMPONENTS

Plywood or plexiglass partition

Attached to inside of cross braces with bolts and wingnuts. Plywood can be painted by local artists. Two sheets of material works if suggested sizes are unavailable.

Bolts with wingnuts

Major components are attached with bolts and wingnuts through pre-drilled holes for easy assembly and disassembly

Planter

6 ft long and rests on the frame's feet

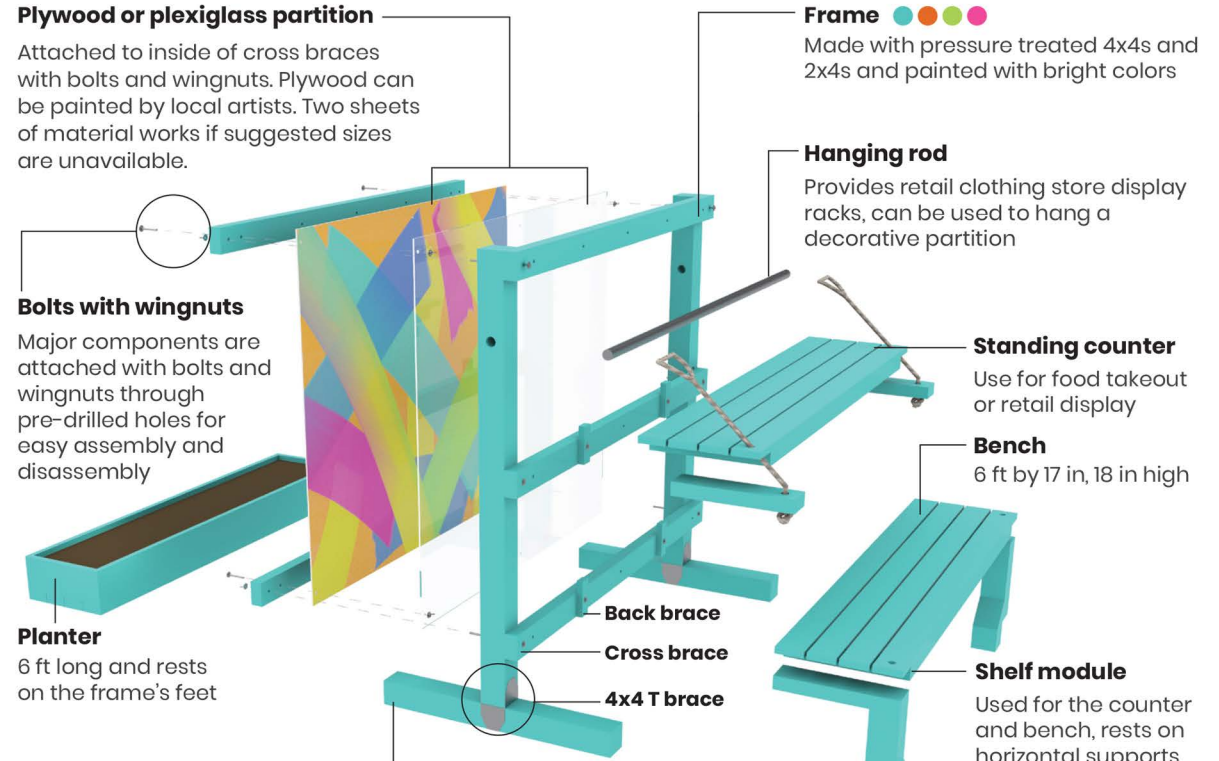

Foot of frame

Frame is movable but may be heavy. Can be transported with a dolly and is compatible with caster wheels.

Bench Construction

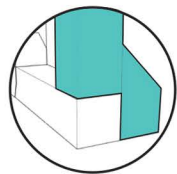

Slats (1x4s)

Shelf base (1x1s)

Horizontal support
rests on cross brace

Notched vertical supports
rest on the frame's feet

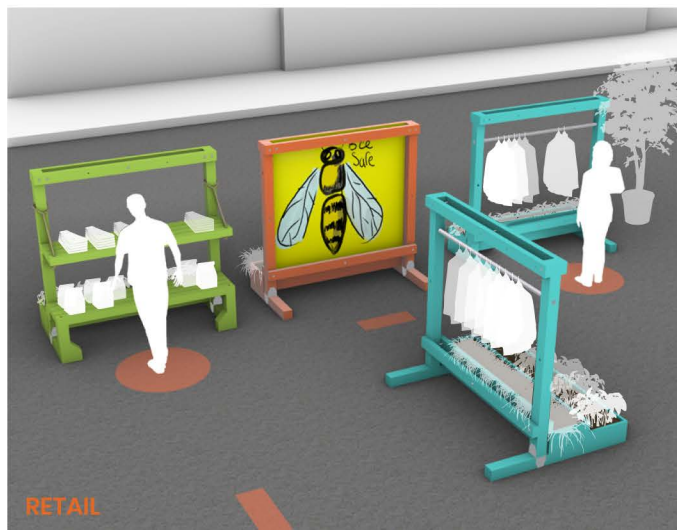
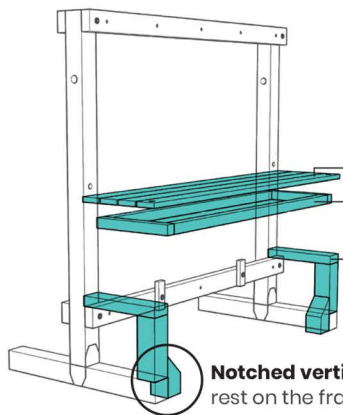

RETAIL

Counter Construction

Rope
Tied through post hole also used for the hanging rod

Shelf module
Rests on horizontal supports

Counter back
Rests on cross brace

Back brace
Holds the counter back in place

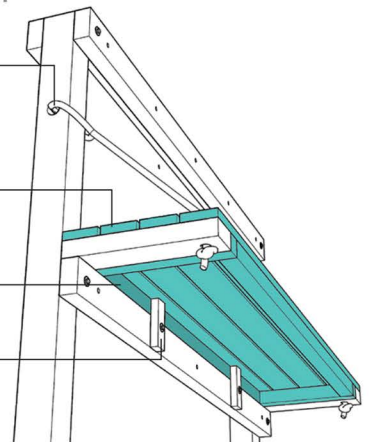

RETAIL

OUTDOOR DINING

FOOD PICKUP

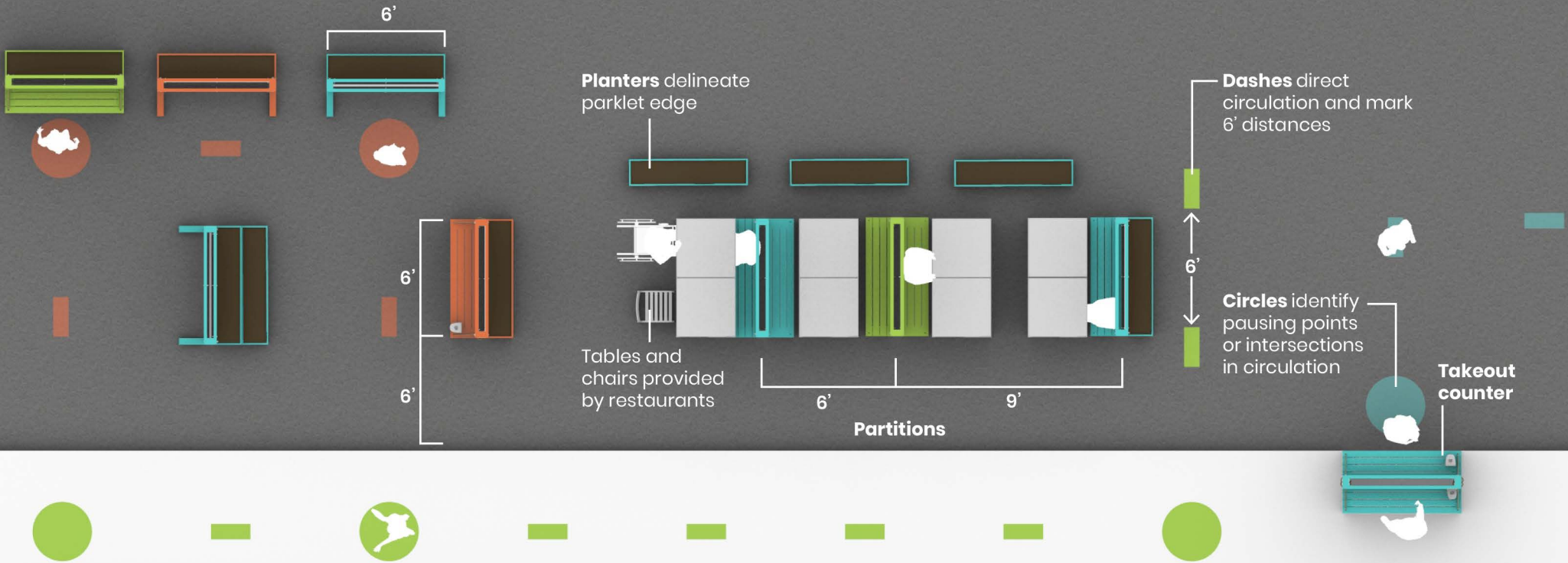

FRAME FEATURES

Shade Opportunities

Umbrella stand fits between the cross braces, providing shade

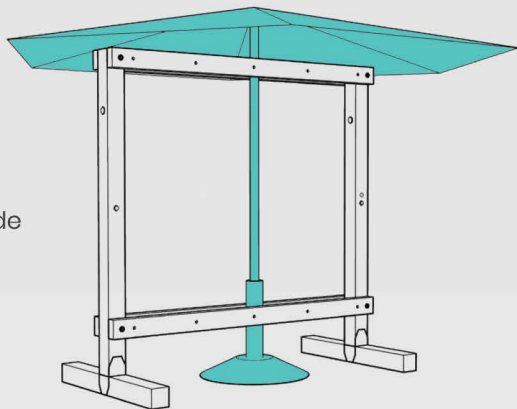

Modular Cross Braces

All cross braces have the same pre-drilled holes for bolts and hand-tightening wing nuts to simplify construction.

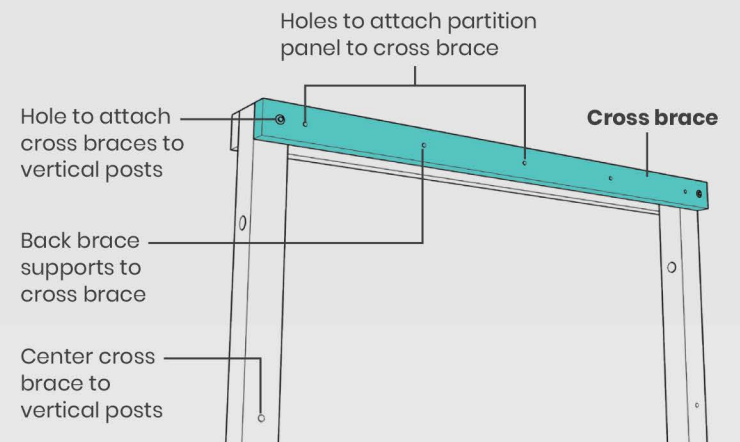



ParKIT

ParKIT

AYERS SAINT GROSS

ABBY THOMAS, MICHAEL MCGRAIN, CONNOR PRICE

ParKIT is a mobile park kit-of-parts, housed in a portable kiosk that can be transported by car. The ParKIT would be part of a larger portable kiosk network that businesses or communities can rent for a designated period of time. It is meant to be easy to transport and assemble. The kiosk comes filled with pop-up park contents, including but not limited to:

- Lightweight, foldable metal bistro sets
- Plastic milk crates that can be assembled into bench seating
- 6-foot diameter outdoor vinyl-coated polyester tarp dots for spatial awareness
- Stencils and supplies for kid's pavement games.
- Traffic and social distancing barriers
- Filled planters
- Signage and assembly instructions

When empty, the kiosk can be used for vending and service industry purposes. All kiosks should be set up to be able to have a power connection and a portable water source. A cleaning kit with instructions will also be provided.

COST



MAINTENANCE



FABRICATION



MATERIALS

- **Trailer**
- **Shed**
- **Mobile concessions sink**
- **Chalk spray paint and stencils**
- **Circle tarps**
- **Milk crates and dowels**
- **Planters**
- **Barriers**
- **Foldable tables and chairs**
- **A-frame for signage**



PLAY

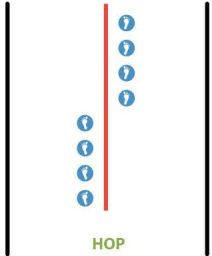

HOP



SKIP

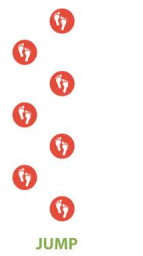

JUMP



BALANCE



Cleaning and Sanitation Process



Remove visible soil and dirt from surfaces using soap and water before use and before returning items inside the ParKIT.

Use an EPA registered disinfectant to routinely disinfect frequently touched surfaces. Use child-friendly cleaning products.



For most effective sanitizing, wait the proper contact time as indicated on the label. Set a cleaning schedule to follow throughout the day



For your safety, we kindly ask that you follow CDC Guidelines to stop the spread of germs

Stay at least 6 feet (about 2 arms' length) away from other people.



Cover your cough or sneeze with a tissue, then throw the tissue in the trash.

Stay home when you are sick, except to get medical care.



Wash your hands often with soap and water for at least 20 seconds.

Avoid touching your eyes, nose, and mouth.



CRATE STACKING LAYOUT

5 STACKS OF 3 ON TOP OF WOOD COUNTER/BOX. OPEN SIDE UP FOR TOP ROW TO HOUSE SMALLER CONTENTS

5' X 7' MIN. METAL FRAMED SHED WITH PLYWOOD EXTERIOR, METAL ROOF AND AWNING FLAP. OPTIONAL: PREFAB. SHED

CONCESSIONS SINK

6 STACKS OF 6 PLUS 2 STACKS OF 4

36" H x 9.5" W x 6.25' L COUNTER BOX THAT SERVES AS THE 4TH WALL ON OPEN SIDE

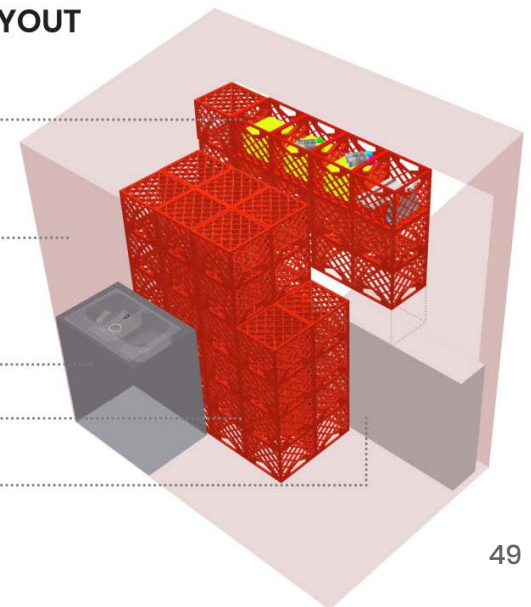

CONTENTS AND PACKING PLAN

START AT THE HITCH END OF THE TRAILER AND WORK YOUR WAY TOWARD THE TAILGATE. SHED SIZE IS 5' x 7' MIN. TO FIT ALL CONTENTS.

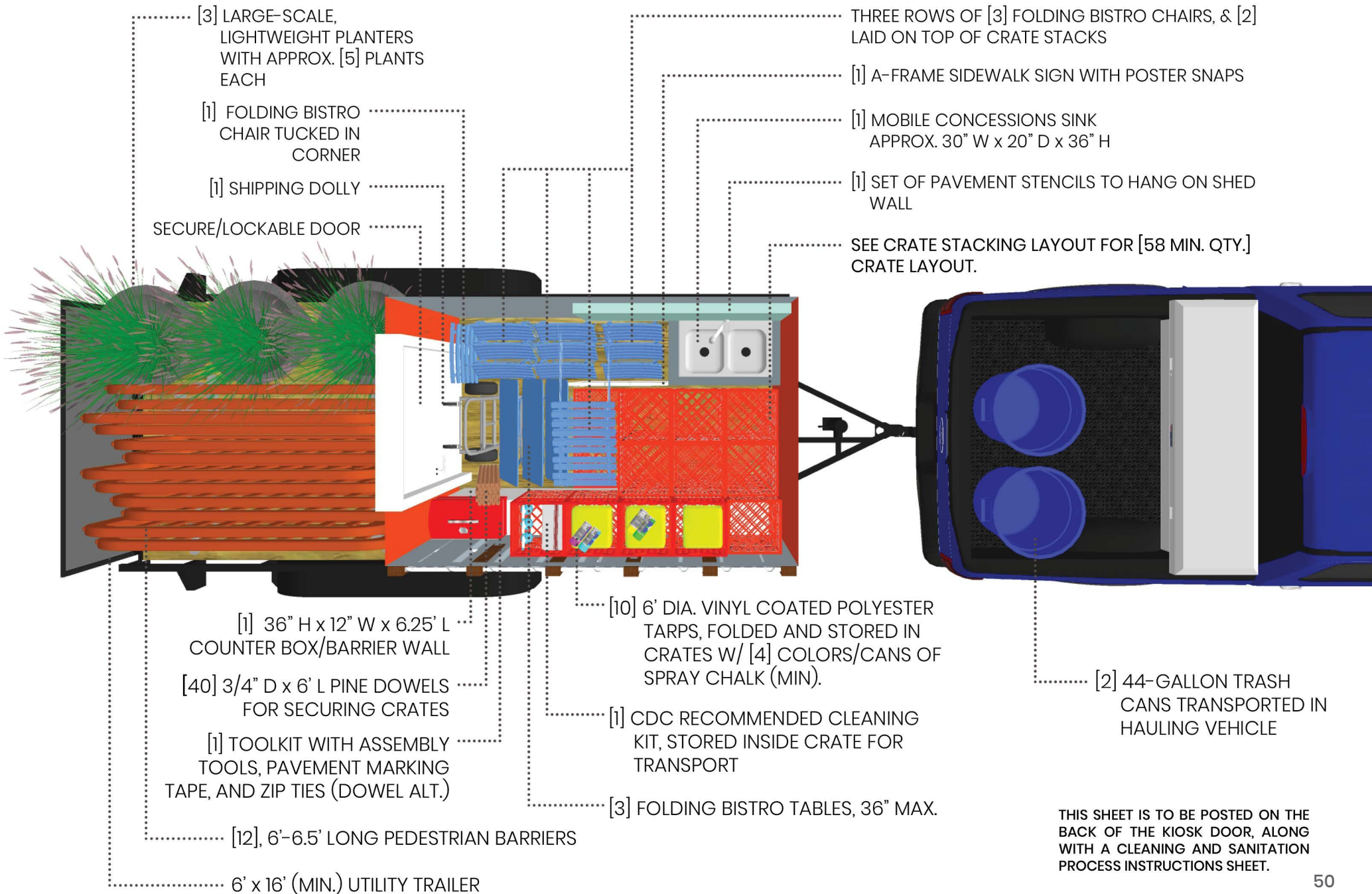

The Food Court



The Food Court

DEPARTMENT DESIGN OFFICE
MAGGIE TSANG, ISAAC STEIN

The Food Court transforms vacant lots into communal, outdoor dining garden. Wildflowers and tall grasses create a buffer zone between the mowed seating areas along a one-way gravel path. An easily assembled umbrella stand provides shade for dining areas and doubles as a light post for the evening. A hand-washing station at the end of the path encourages public health practices. In general, the planted areas of the Food Court increase stormwater infiltration, help reduce heat island effects, and add public green space.

The Food Court can be adapted to any number of vacant lots, implemented by a single dining establishment, or shared between multiple retailers. The plans shown demonstrate a typical application for a small lot and a large lot. There are five key steps to establishing a Food Court: 1) Clear and till the lot; 2) Stake the path 3) Seed grass, plant trees, and water; 4) Mow or trim back dining areas; 5) Furnish with tables, chairs, signage, and a handwashing station. Already grassy or overgrown lots can easily be converted by clearing a path and mowing seating areas. Furnishings can be customized or assembled with a simple set of off-the-shelf materials.

COST



MAINTENANCE



FABRICATION



MATERIALS

- 6"x6" cedar posts
- Plumbing components
- Gravel
- Steel edging
- Trash can(s)
- 4"-6" caliper Silver/Red Maple, Black Locust, or similar tree(s)
- Painted sheet metal welded to rebar
- Umbrella
- Lighting
- Dining and seating furnishings
- Grass seed mix, if needed

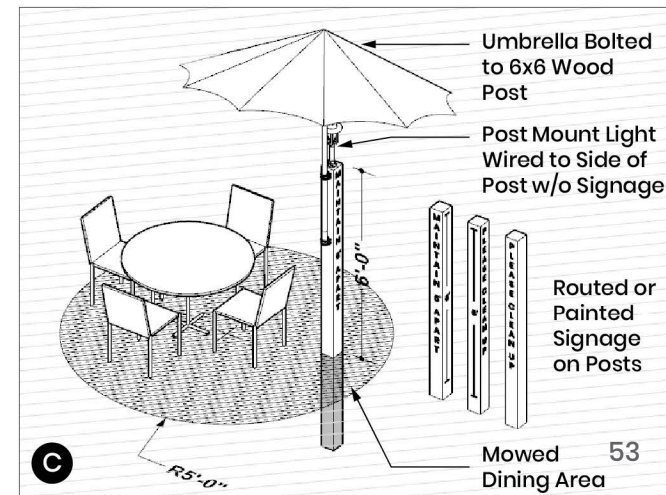
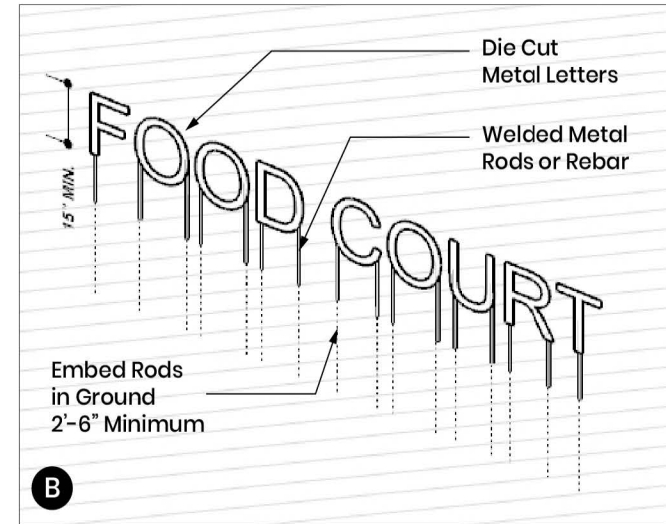
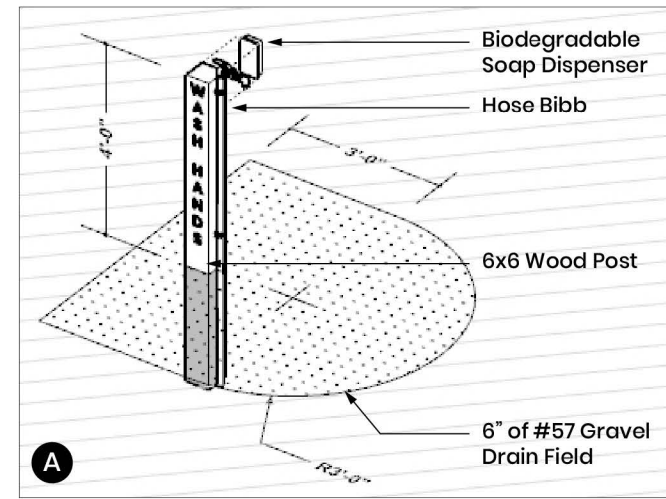
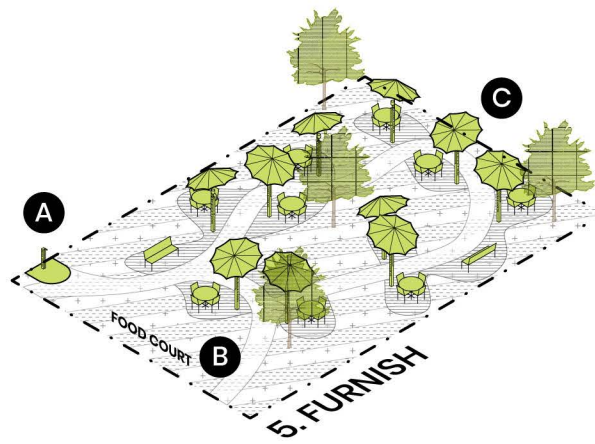
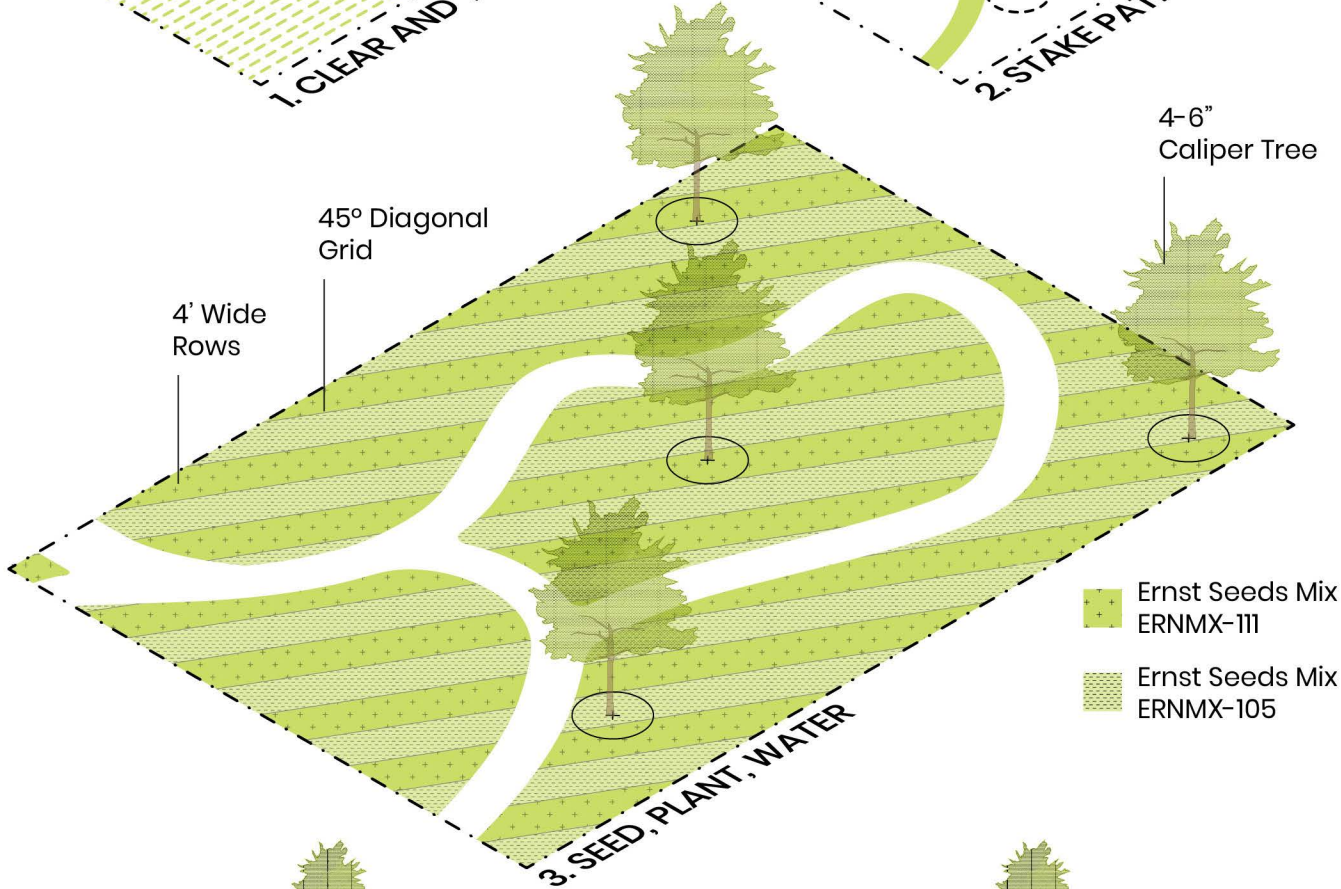
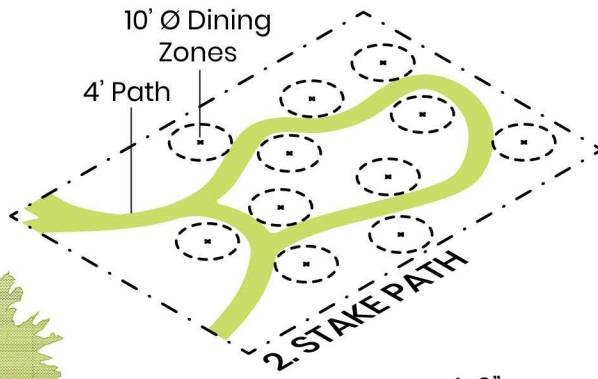
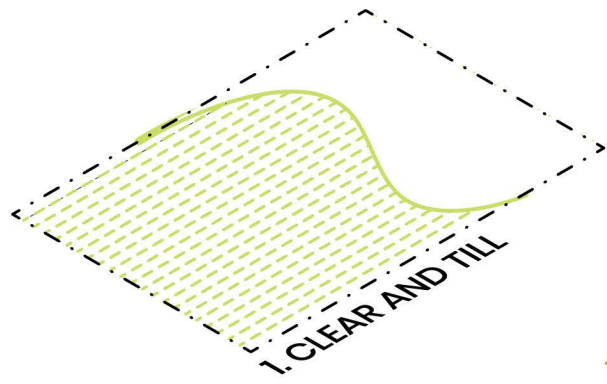

Small Lot

Large Lot

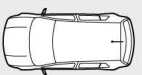
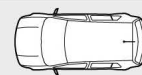
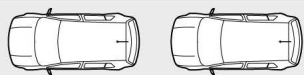
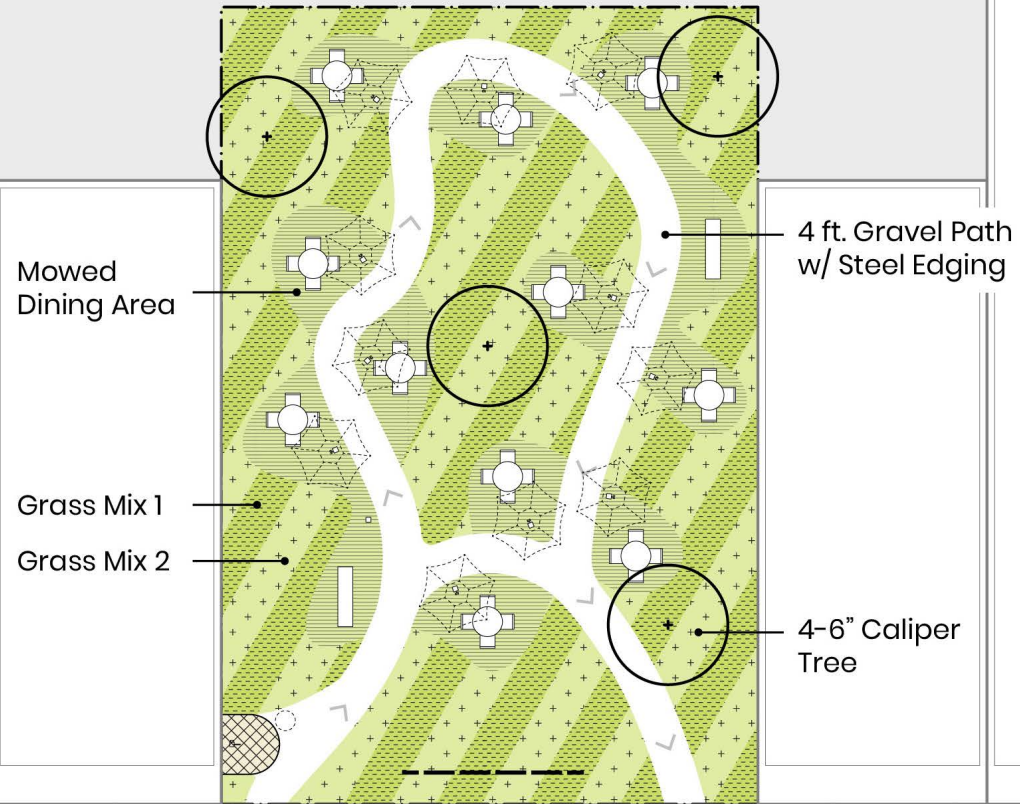
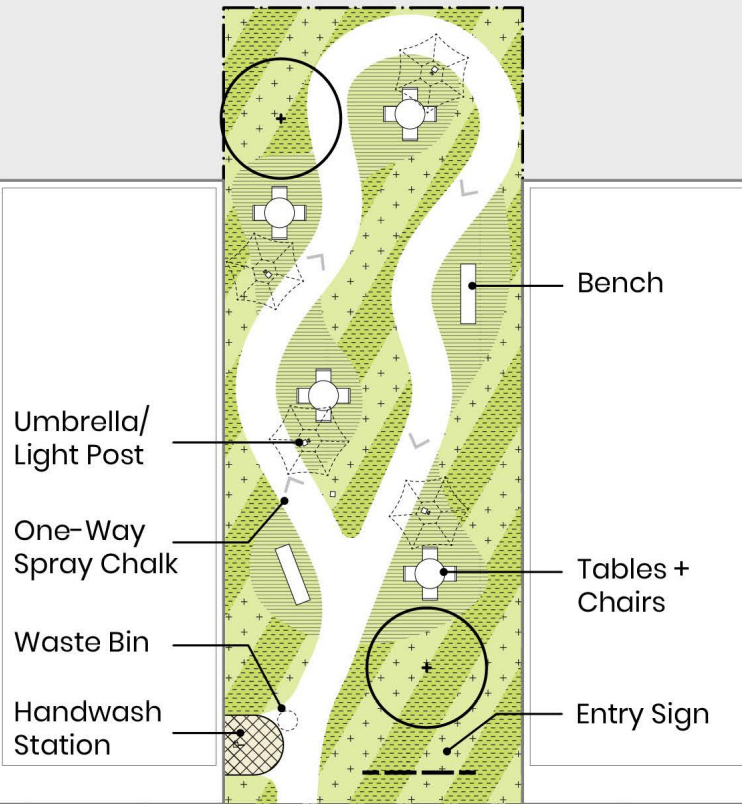

Plan

0' 20'

Public Health Guidelines



Public Health Recommendations

CREATING SAFE, ACCESSIBLE, AND EQUITABLE PUBLIC SPACES

PRIMARY CONSIDERATIONS

- All efforts should follow CDC guidance for reopening.
- Efforts to shape public spaces should embrace the [Guiding Principles of Inclusive Healthy Places](#). These guiding principles can inform strategies for shaping public space projects that promote accessibility and diverse social interactions, reflect shared social values, advance equity, and are welcoming for all.

SUGGESTED STRATEGIES DESIGNS MIGHT CONSIDER OR INCLUDE

- Outdoor seating that supports physical distancing, is publicly accessible, and is not limited to patrons of any particular business.
- Proper signage for physical distancing that includes information on how to stop the spread of COVID-19, including reminders for people to avoid public spaces settings if symptomatic. All signage should be available in languages appropriate to the host community.
- Touchless hand-washing spaces and automatic dispensers for hand sanitizer.
- Provision of masks for patrons who arrive without them.



Traveling to/from Business Districts

PRIMARY CONSIDERATIONS

- Designs should consider pedestrians, bicycle riders, public transit riders, and micro mobility (e.g., scooter) riders as the primary users.
- Designs should take advantage of street closures, where they exist.

SUGGESTED STRATEGIES DESIGNS MIGHT CONSIDER OR INCLUDE

- Adding temporary bicycle and pedestrian travel lanes; flexible bollards; reducing speed limits (and enforcing limits in a way that does not unintentionally increase racial profiling); turning parking areas into spaces for pedestrians and bicyclists to travel; creating one-way travel lanes to improve traffic flow and improve physical distancing; ensuring that all existing bicycle lanes and sidewalks are well-maintained; and reprogramming pedestrian crosswalks so pressing the “beg” button is not necessary for safe crossing.



Planning for Safe Food Businesses

PRIMARY CONSIDERATIONS

- While acknowledging the importance of drive-through, delivery, and curbside pick-up, designs should focus on the needs of the pedestrian, biker, scooter rider, public transportation user accessing businesses.
- Where possible, food businesses should consider utilizing nearby open space for dining (e.g., closed roads, parking lots)
- All designs should support easy maintenance of safe physical distance among workers, patrons, and pedestrians.

SUGGESTED STRATEGIES DESIGNS MIGHT CONSIDER OR INCLUDE

- Encouraging healthy hygiene practices and physical distancing among workers and patrons by creating designated areas for (1) arrival or waiting, (2) food pick up, (3) dining, (4) receiving (for delivery of goods), and (5) waste management.
- Clearly signaling to workers and patrons with signage, tape, chalk, or other physical barriers how to maintain physical distance of at least six feet.
- Portable handwashing stations with foot-pedal operation, hand-sanitizer dispensers, and signage for proper hand washing; touch-free trash receptacles; and face covering for those who need them.

CONTINUED...



Planning for Safe Food Businesses

- Check-in table on arrival or waiting area, with a physical barrier or partition, to screen for symptoms of illness or potential exposure to COVID-19.
- Food pick-up areas with raised surfaces (e.g., table, cart, shelving) for boxes or bags. There should be ample space behind the raised platform for workers to facilitate “no contact” transfers at pick up.
- Barriers, at least 3 ft tall for easy viability, placed around outdoor dining areas to prevent excess foot traffic.
- No-touch, closed-lid trash receptacles, accompanied by instructional signage for disposal of PPE.
- No self-serving stations (e.g., for beverages, condiments, buffets, etc.); or shared table items (e.g., condiment bottles, salt and pepper shakers, napkin holders, etc.).
- Bathrooms that utilize touch-free technology where possible, including sinks with hot running water for hand washing, soap dispensers, paper towel dispensers, and closed-lid trash receptacles. Bathrooms should also be meticulously cleaned and disinfected frequently. Doors (e.g., leading into the restaurant) that are frequently used should be touch-free or propped open whenever possible to limit touching of door handles, and there should be a clearly marked path that promotes physical distancing from entryway to bathroom facilities.
- The safe movement of pedestrian traffic (i.e. safe pedestrian passage through an outdoor seating area, or queuing area, is necessary). The use of adjacent parking should be considered for this purpose, where existing sidewalks are too narrow.
- Single-use menus, chalkboard / sign menus or electronic menus that can be viewed on personal electronic devices.

Additional Resources

Tactical Urbanism Interventions

[Tactical urbanism guide to materials and more](#)

[NACTO guidance - Streets for Pandemic Responses](#)

[Smart Growth - map showing different responses from across the country](#)

[Mass Design Group - Spatial Strategies for Restaurants in Response to COVID-19](#)

Inclusive Public Space

[Gehl Institute, "Inclusive Healthy Places"](#)

Public Health Resources

[CDC Communications Resources](#)

[CDC Guidance for Businesses and Workplaces](#)

[CDC Restaurants and Bars Decision Tool](#)

[CDC Guidance for Cleaning and Disinfecting Public Spaces](#)

[FDA "Best Practices for Retail Food Stores, Restaurants, and Food Pick-Up/Delivery Services During the COVID-19 Pandemic"](#)

[James Beard Foundation & the Food and Society Program at the Aspen Institute, "Safety First: Serving Food and Protecting People During COVID-19"](#)

[U.S. Department of Labor, "Guidance on Preparing Workplaces for COVID-19"](#)

[National Restaurant Association, "COVID-19 Reopening Guidance"](#)

[National Association of City Transportation Officials, "COVID-19: Transportation Response Center"](#)

**Did you find this guide useful?
Reach out to us!**

**We'd love to see how you're
making your community safer.**

designfordistancing.org designfordistancing@ndc-md.org

Design **For**
Distancing

REOPENING BALTIMORE TOGETHER